

Roland

RD-88

Parameter Guide

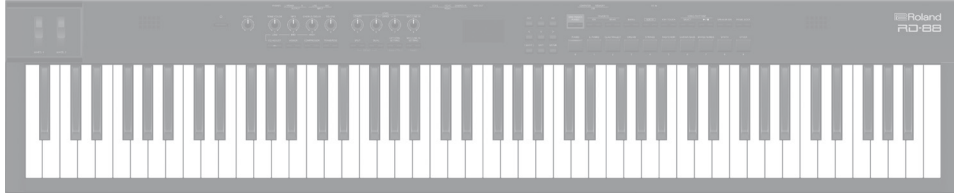

Contents

Scene Parameter	4	Speaker Sim (Speaker Simulator)	24
COMMON	4	Phaser	25
ZONE EDIT	4	Small Phaser	25
INTERNAL	4	Script 90	25
EXTERNAL	5	Step Phaser	26
KEY TOUCH	6	M StagePhsr (Multi Stage Phaser)	26
ASSIGN	6	Inf Phaser (Infinite Phaser)	26
PEDAL	6	Ring Mod (Ring Modulator)	27
WHEEL	6	Tremolo	27
KNOB	7	Auto Pan	27
CTRL SRC SEL	7	Slicer	28
ZONE SOUND	7	Rotary	28
TONE COLOR	7	VK Rotary	29
GENERAL	7	Chorus	29
Pitch	8	Flanger	30
MODIFY	8	StepFlanger	30
SCALE TUNE	8	Hexa-Chorus	31
ZONE EFFECTS	9	Trem Chorus (Tremolo Chorus)	31
EQ	9	Space-D	32
MFx	9	Overdrive	32
SCENE EFFECTS	9	Distortion	32
SYMPATHETIC RESO	9	T-Scream	32
IFx	9	Gt Amp Sim (Guitar Amp Simulator)	33
CHORUS	10	Compressor	34
REVERB	11	Limitter	34
SYSTEM EFFECTS Parameter	14	Sustainer	34
SYS CHORUS	14	Gate	34
SYS REVERB	14	Delay	35
MASTER EQ	14	Mod Delay (Modulation Delay)	35
MASTER COMP	15	3Tap PanDly	36
SYSTEM Parameter	16	4Tap PanDly	37
GENERAL	16	MultiTapDly	38
KEY TOUCH	16	Reverse Dly	39
ASSIGN	17	TimeCtrlDly (Time Control Delay)	40
PEDAL	17	Tape Echo	40
WHEEL	17	LOFI Comp (Lo-Fi Compressor)	41
KNOB	17	Bit Crasher	41
MIDI	18	PitchShiftr (Pitch Shifter)	41
GENERAL	18	2V PShifter (2 Voice Pitch Shifter)	42
MIDI TX	18	OD → Chorus (Overdrive 0 Chorus)	42
MIDI RX	18	OD → Flanger (Overdrive 0 Flanger)	43
LOCAL SW	18	OD → Delay (Overdrive 0 Delay)	43
USB AUDIO	19	DS → Chorus (Distortion 0 Chorus)	44
SCALE TUNE	19	DS → Flanger (Distortion 0 Flanger)	44
INPUT SETTING	20	DS → Delay (Distortion 0 Delay)	45
GENERAL	20	OD/DS → T. Wah (Overdrive/Distortion 0 Touch Wah)	45
INPUT REVERB	20	OD/DS → A. Wah (Overdrive/Distortion 0 Auto Wah)	46
INPUT EQ	20	Gt → Chorus (Guitar Amp Simulator → Chorus)	47
MFx/IFx Parameters	21	GT → Flanger (Guitar Amp Simulator → Flanger)	48
Thru	21	Gt → Phaser (Guitar Amp Simulator → Phaser)	49
Equalizer	21	Gt → Delay (Guitar Amp Simulator → Delay)	50
Spectrum	21	EP → Tremolo (EP Amp Simulator → Tremolo)	51
Isolator	22	EP → Chorus (EP Amp Simulator → Chorus)	51
Low Boost	22	EP → Flanger (EP Amp Simulator → Flanger)	52
SuperFilter	22	EP → Phaser (EP Amp Simulator → Phaser)	52
Step Filter	23	EP → Delay (EP Amp Simulator → Delay)	53
Enhancer	23	Enhncr → Cho (Enhancer → Chorus)	53
Auto Wah	23	Enhncr → FI (Enhancer → Flanger)	54
Humanizer	24	Enhncr → Dly (Enhancer0 Delay)	54
		Chorus → Dly (Chorus → Delay)	55
		Flanger → Dly (Flanger → Delay)	55
		Chorus → FI (Chorus → Flanger)	56
		CE-1 (Chorus)	56

SBF-325 (Flanger)	56
SDD-320 (Dimension D)	57
2Tap PanDly (2 Tap Pan Delay)	57
Transient	58
Mid-Side EQ (Mid-Side Equalizer).....	58
M/S Comp (Mid-Side Compressor).....	59
Fattener (Tone Fattener)	60
M/S Delay (Mid Side Delay)	60
EP Amp Sim (RD EP Amp Simulator)	61
DJFX Looper.....	61
BPM Looper	62
Saturator	62
W Saturator (Worm Saturator).....	63
Fuzz.....	63
JUNO Chorus (JUNO-106Chorus)	63
MM Filter (Multimode Filter)	64
HMS Distort	64
Script 100	64
Note	64

Scene Parameter

Here's how to edit settings for the currently selected scene.

1. Press the [MENU] button.
2. Use the cursor [▲] [▼] buttons to select "SCENE EDIT," and press the [ENTER] button.
3. Use the cursor [▲] [▼] buttons to select the item that you want to edit, and press the [ENTER] button.
4. Use the cursor [▲] [▼] buttons to select a parameter, and use the [DEC] [INC] buttons to edit the value.

COMMON

Settings for the entire scene.

Parameter	Value	Explanation
Level	0–127	Specifies the volume of the scene.
Tempo	20–250	Specifies the tempo of the scene. This affects the effect settings, etc.
Voice Reserve Z1–Z3	0–10	Specifies the number of voices that are reserved for each zone when you attempt to play more voices than the maximum available.

ZONE EDIT

Settings for zones 1–3 (UP1/UP2/LOW).

* Settings for sound engine control.

INTERNAL

Settings for each zone for the internal sound engine of the RD-88 unit.

Parameter	Value	Explanation
Bank	SN PR-A, SN PR-B, RD-88, PR-A, PR-B, PR-C, PR-D, PR-E, COMMON, USER, EXZ001	Selects the tone bank.
(Number / Name)	****	Selects the tone.
Level	0–127	Specifies the volume of each zone.
Pan	L64–63R	Specifies the panning of each zone when using stereo output.
Kbd Sw (Keyboard Switch)	OFF, ON	Switches the zone on/off for playing from the keyboard.
Rx Ch (Rx Channel)	1–16	Specifies the MIDI receive channel of each zone.
Cho Send (Chorus Send Level)	0–127	Specifies the send level to chorus.
Rev Send (Reverb Send Level)	0–127	Specifies the send level to reverb.
Output (Output Assign)	Selects the output destination.	
	DRY	Output without passing through the effects.
	IFX	Send to IFX.
	SYM-RESO	Send to Sympathetic Resonance.

Parameter	Value	Explanation
Key Rng Low (Key Range Lower)	C-1–UPPER	Specifies each zone's key range. Make this setting when you want to play different tones in different regions of the keyboard. Specify the lowest key (Key Rng Low) and the highest key (Key Rng Upp) of the desired region.
Key Rng Upp (Key Range Upper)	LOWER–G9	
Velo Max (Velocity Max)	1–127	Specifies the maximum velocity when you play a key. With a low value of this setting, the volume will not become very loud even if you play a key strongly.
Velo Sens (Velocity Sensitivity)	-63–+63	Specifies how the volume responds to the key velocity. With positive (+) values, the volume increases as you play more strongly; with negative values (-), the volume decreases as you play more strongly.
Velo Rng Low (Velocity Range Lower)	1–UPPER	Specify the lower limit (Velo Rng Low) and upper limit (Velo Rng Upp) of key velocities that will play the tone. Make these settings when you want to use velocity to switch between tones.
Velo Rng Upp (Velocity Range Upper)	LOWER–127	
Coarse Tune	-48–+48	Specifies the pitch in semitone units.
Fine Tune	-50–+50	Finely adjusts the pitch in one-cent units.
Ctrl Damper (Damper Pedal)	OFF, ON	Specifies whether damper pedal operations are received (ON) or not received (OFF).
Ctrl FC1 (FC1 Pedal)	OFF, ON	Specifies whether FC1 pedal operations are received (ON) or not received (OFF).
Ctrl FC2 (FC2 Pedal)	OFF, ON	Specifies whether FC2 pedal operations are received (ON) or not received (OFF).
Ctrl Wheel1 (Wheel 1)	OFF, ON	Specifies whether WHEEL1 operations are received (ON) or not received (OFF).
Ctrl Wheel2 (Wheel 2)	OFF, ON	Specifies whether WHEEL2 operations are received (ON) or not received (OFF).
Ctrl Knob1 (Control Knob 1)	OFF, ON	Specifies whether KNOB1 operations are received (ON) or not received (OFF).
Ctrl Knob2 (Control Knob 2)	OFF, ON	Specifies whether KNOB2 operations are received (ON) or not received (OFF).
Ctrl Knob3 (Control Knob 3)	OFF, ON	Specifies whether KNOB3 operations are received (ON) or not received (OFF).
Ctrl Knob4 (Control Knob 4)	OFF, ON	Specifies whether KNOB4 operations are received (ON) or not received (OFF).
Ctrl Knob5 (Control Knob 5)	OFF, ON	Specifies whether KNOB5 operations are received (ON) or not received (OFF).
Ctrl Knob6 (Control Knob 6)	OFF, ON	Specifies whether KNOB6 operations are received (ON) or not received (OFF).
Ctrl Knob7 (Control Knob 7)	OFF, ON	Specifies whether KNOB7 operations are received (ON) or not received (OFF).
Ctrl Knob8 (Control Knob 8)	OFF, ON	Specifies whether KNOB8 operations are received (ON) or not received (OFF).

EXTERNAL

External MIDI device settings for each zone.

Parameter	Value	Explanation
Tx Mode (Tx Mode)	ON	Normally, you'll use this value. The same MIDI messages are transmitted to the RD-88's internal sound engine and to an external MIDI device. Tone selection and switching messages (bank select and program change) will be the settings of the tone selected for that zone. MEMO If Tx Mode is ON, the settings of the [INTERNAL] tab are enabled, and the settings of the [EXTERNAL] tab are ignored. If you want to enable the parameters of the [EXTERNAL] tab and control an external device, set Tx Mode to "EXT."
	INT	Use this setting if you want a specific zone to not transmit MIDI messages to an external MIDI device. Use the INT setting if you want to play only the internal sounds of the RD-88.
	EXT	Choose this setting if you're using the RD-88 as a master keyboard to control an external MIDI device.
Ext Port (Output Port)	ALL, MIDI, USB	Specifies the connector that transmits control messages. If this is "ALL," messages are transmitted both from the MIDI OUT connector and the USB port.
Ext Ch (Tx Channel)	1–16	Specifies the MIDI transmit channel.
Bank MSB	OFF, 0–127	Enter numerical values for the program number and bank select MSB/LSB to switch sounds on an external MIDI device.
Bank LSB	OFF, 0–127	
Ext PC (Program Change)	OFF, 1–128	
Ext Volume (Volume)	OFF, 0–127	Adjusts the volume of the external MIDI device.
Ext Pan (Pan)	OFF, L64–63R	Sets the pan of the external MIDI device.
Ext Chorus (Chorus Send Level)	OFF, 0–127	Sets the Chorus Send Level of the external MIDI device.
Ext Reverb (Reverb Send Level)	OFF, 0–127	Sets the Reverb Send Level of the external MIDI device.
Ext Mono/Poly (Mono/Poly)	OFF, MONO, POLY	Sets the Mono/Poly setting of the external MIDI device.
Ext Attack (Attack Time Offset)	OFF, 0–127	Sets the Attack Time Offset of the external MIDI device.
Ext Decay (Decay Time Offset)	OFF, 0–127	Sets the Decay Time Offset of the external MIDI device.
Ext Release (Release Time Offset)	OFF, 0–127	Sets the Release Time Offset of the external MIDI device.
Ext Cutoff (Cutoff Offset)	OFF, 0–127	Sets the Cutoff Offset of the external MIDI device.
Ext Reso (Resonance Offset)	OFF, 0–127	Sets the Resonance Offset of the external MIDI device.
Ext Porta Sw (Portamento Switch)	OFF, P-OFF, P-ON	Sets the Portamento of the external MIDI device.
Ext Porta Tm (Portamento Time)	OFF, 0–127	Sets the Portamento Time of the external MIDI device.
Ext C. Tune (Coarse Tune)	OFF, -48–+48	Sets the Coarse Tune of the external MIDI device.

Parameter	Value	Explanation
Ext F. Tune (Fine Tune)	OFF, -50–+50	Sets the Fine Tune of the external MIDI device.
Ext Bend Rng (Bend Range)	OFF, 0–48	Sets the Bend Range of the external MIDI device.
Ext Mod Dpth (Modulation Depth)	OFF, 0–127	Sets the Modulation Depth of the external MIDI device.
Ext M. Vol Sw (External Control Volume Knob)	OFF, ON	Specifies whether master volume operations are transmitted (ON) or not transmitted (OFF). Turn the Ext M. Vol Sh ON when you want to use the master volume to also adjust the volume of the external MIDI device.
Ext CC1 Num (User Control Change 1 Number)	OFF, 0–127	These parameters let you specify and transmit two types of control change message.
Ext CC1 Val (User Control Change 1 Value)	0–127	
Ext CC2 Num (User Control Change 2 Number)	OFF, 0–127	
Ext CC2 Val (User Control Change 2 Value)	0–127	

KEY TOUCH

External MIDI device settings for each zone.

Parameter	Value	Explanation
Source	SCENE, SYS	Specifies whether the keyboard touch settings are specified by the settings of the scene (SCENE) or by the system settings (SYS).
	SPR LIGHT	An even lighter setting than LIGHT.
Velo Crv (Velocity Curve)	LIGHT	Specifies a light keyboard touch response. Since you can produce fortissimo (ff) using an even lighter touch than with the MEDIUM setting, this feels as though the keyboard is lighter. This setting is easy to play even by those whose hands have less strength.
	MEDIUM	Specifies the standard keyboard touch response. This allows playing with the most natural touch. This is closest to the touch of an acoustic piano.
	HEAVY	Specifies a heavy keyboard touch response. Since producing fortissimo (ff) requires you to play with a stronger touch than with the MEDIUM setting, this feels as though the keyboard is heavier. This setting allows even greater expressiveness when you play dynamically.
	SPR HEAVY	An even heavier setting than HEAVY.
Velo Offset (Velocity Sense Offset)	-10~+9	Finely adjusts the keyboard touch response in greater detail than the Velocity Curve setting. This lets you specify detailed settings between the various Velocity Curve values. Higher values make the touch feel heavier. If this value exceeds the upper or lower limit, the Velocity Curve also switches automatically between its five values as appropriate.
Velocity	REAL,	The volume and character of the sound responds to your keyboard playing dynamics.
	1-127	The volume and character of the sound remains fixed regardless of your keyboard playing dynamics.
Velo Dly Sens (Velocity Delay Sense)	-63~+63	Specifies the delay from the moment you press the key until the sound is heard. Negative values delay the timing at which the sound is heard when you press the key strongly. Positive values delay the timing at which the sound is heard when you press the key softly.
Velo Keyfollow (Velocity Key Follow Sense)	-63~+63	Specifies how keyboard touch is affected by the keyboard range. With higher values, the keyboard feels heavier as you play upward and lighter as you play downward.
KeyOff Pos (Key Off Position)	STANDARD	Note-off occurs at the same key depth as a conventional piano.
	DEEP	Note-off occurs at a deeper key depth. This is appropriate for sounds such as electric piano.

ASSIGN

Keyboard touch settings (for each individual scene).

PEDAL

Parameter	Value	Explanation
Source	SCENE, SYS	Specifies whether the parameters controlled by the pedals are specified by the settings of the scene (SCENE) or by the system settings (SYS).
FC1 (FC1 Function)	Specifies the function that is assigned to the FC1 pedal when Source is set to "SCENE."	
	OFF	No function is assigned.
	CC01-31, 32 (OFF), 33-95	Controller number 1-31, 32, 33-95
	AFT	Aftertouch
	BEND DOWN	Lower the pitch.
	BEND UP	Raise the pitch.
	SCENE DOWN	Switch the scene to the previous number.
	SCENE UP	Switch the scene to the next number.
FC2 (FC2 Function)	Specifies the function that is assigned to the FC2 pedal when Source is set to "SCENE."	
	OFF	No function is assigned.
	CC01-31, 32 (OFF), 33-95	Controller number 1-31, 32, 33-95
	AFT	Aftertouch
	BEND DOWN	Lower the pitch.
	BEND UP	Raise the pitch.
	SCENE DOWN	Switch the scene to the previous number.
	SCENE UP	Switch the scene to the next number.
START/STOP	Play/stop the rhythm or audio file.	

WHEEL

Parameter	Value	Explanation
Wheel1 Src (Wheel1 Source)	SCENE, SYS	Specifies whether the parameter controlled by WHEEL1 is specified by the settings of the scene (SCENE) or by the system settings (SYS).
Wheel1 (Wheel1 Function)	Specifies the function that is assigned to WHEEL1 when Source is set to "SCENE."	
	OFF	No function is assigned.
	CC01-31, 32 (OFF), 33-95	Controller number 1-31, 32, 33-95
	AFT	Aftertouch
Wheel2 Src (Wheel2 Source)	Specifies whether the parameter controlled by WHEEL2 is specified by the settings of the scene (SCENE) or by the system settings (SYS).	
	SCENE, SYS	Specifies whether the parameter controlled by WHEEL2 is specified by the settings of the scene (SCENE) or by the system settings (SYS).

Parameter	Value	Explanation
Wheel2 (Wheel2 Function)	Specifies the function that is assigned to WHEEL2 when Source is set to "SCENE."	
	OFF	No function is assigned.
	CC01–31, 32 (OFF), 33–95	Controller number 1–31, 32, 33–95
	AFT	Aftertouch
	BEND DOWN	Lower the pitch.
	BEND UP	Raise the pitch.

KNOB

Parameter	Value	Explanation
Source	SCENE, SYS	Specifies whether the parameters controlled by KNOB 1–8 are specified by the settings of the scene (SCENE) or by the system settings (SYS).
Knob1–Knob8 Knob1 Function–Knob 8 Function	Specify the functions that are assigned to KNOB 1–8 when Source is set to "SCENE."	
	OFF	No function is assigned.
	CC01–31, 32 (OFF), 33–95	Controller number 1–31, 32, 33–95
	AFT	Aftertouch
	BEND DOWN	Lower the pitch.
	BEND UP	Raise the pitch.

CTRL SRC SEL

Parameter	Value	Explanation
Src1 (Control Source (1))	OFF, CC01–CC31, CC33–CC95, BEND, AFT	Specify the MIDI message that modifies the parameter.
Src2 (Control Source (2))		
Src3 (Control Source (3))		
Src4 (Control Source (4))		

ZONE SOUND

Settings for zones 1–3 (UP1/UP2/LOW).

* Settings for sound engine control.

TONE COLOR

Parameter	Value	Explanation
Type (Tone Color Type)	EQ	Lets you adjust EQ with a single knob. Turning the knob toward the left boosts the mid-frequency range, and turning the knob toward the right boosts the high- and low-frequency ranges. By adjusting this appropriately for the conditions of your performance, you can make the sound easier to hear.
	STEREO WIDTH	If the sound is being output in stereo, turning the knob toward the left gradually changes the output to mono, and turning the knob toward the right gradually changes to stereo. Depending on the conditions of your performance, mono output might be easier to hear.
Level (Tone Color Level)	0–127	Adjusts the depth of TONE COLOR.

GENERAL

Parameter	Value	Explanation
Mono/Poly	MONO, POLY, TONE	Choose " MONO " if you want the tone assigned to the zone to play monophonically, or " POLY " if you want it to play polyphonically. Choose " TONE " if you want to use the setting of the tone.
Legato Sw (Legato Switch)	OFF, ON, TONE	When playing monophonically, you can apply legato. " Legato " is a playing technique in which notes are played smoothly without a break between them. This produces an effect similar to the guitar technique of hammering-on and pulling-off. Choose " ON " to apply legato, or " OFF " if you don't want to apply legato. Choose " TONE " if you want to use the setting of the tone.
Porta Sw (Portamento Switch)	OFF, ON, TONE	Specifies whether portamento is applied. Choose " ON " if you want to apply portamento, or " OFF " if you don't want to apply portamento. Choose " TONE " if you want to use the setting of the tone.
Porta Time (Portamento Time)	0–127, TONE	Specifies the time over which the pitch changes when applying portamento. With higher values, the pitch change to the next note takes longer. Choose " TONE " if you want to use the setting of the tone.
Unison Sw (Unison Switch)	OFF, ON, TONE	This function layers a single sound. Choose " ON " if you want to apply unison, or " OFF " if not. Choose " TONE " if you want to use the setting of the tone.
Velo Crv Type (Velocity Curve Type)	OFF, 1–4	For each zone, selects one of four velocity curves suitable for the keyboard touch of your MIDI keyboard. If you want to play the sounds using the velocity curve of this unit's keyboard, choose " OFF ."

Pitch

Parameter	Value	Explanation
Bend Range	0–24, TONE	Specifies the amount of pitch change that occurs when you move a controller if pitch bend is assigned to that controller (maximum two octaves).
Bend Mode	Specifies the behavior of a controller if pitch bend is assigned to that controller.	
	NORMAL	The conventional pitch bend effect is applied.
	C+L (CATCH+LAST)	The pitch bend effect applies only to the last-played note. If a note-on occurs while pitch bend is already applied, that note sounds at its center pitch. Its pitch begins changing after the controller passes through the center position.
	TONE	The setting of the tone is used.

MODIFY

Parameter	Value	Explanation
Cutoff (Cutoff Offset)	-64–+63	Adjusts the openness of the filter. Higher values make the sound brighter, and lower values make it darker.
Resonance (Resonance Offset)		Boosts the sound in the region of the cutoff frequency, giving it a distinctive character. Raising this value excessively might cause oscillation and distortion. Higher values produce a stronger character, and lower values produce a weaker character.
Attack (Attack Time Offset)		Adjusts the time from when the key is pressed until the attack is completed. Higher values make the attack more gradual, and lower values make the attack sharper.
Decay (Decay Time Offset)		Adjusts the time over which the volume decreases after the attack. Higher values lengthen this decay time, and lower values shorten it.
Release (Release Time Offset)		Adjusts the time from when the key is released until the sound diminishes to silence. Higher values lengthen this release time, and lower values produce a crisper sound.
Vib Rate (Vibrato Rate)		Adjusts the vibrato rate (the speed at which the pitch is modulated). Higher values make pitch modulation faster, and lower values make it slower.
Vib Depth (Vibrato Depth)		Adjusts the vibrato depth (the depth to which the pitch is modulated). Higher values make vibrato deeper, and lower values make it less deep.
Vib Delay (Vibrato Delay)		Adjusts the time until the vibrato (pitch modulation) effect starts being applied. Higher values produce a longer delay until the effect is applied, and lower values produce a shorter delay.
Velo Sens (Velocity Sens Offset)		Adjusts the velocity sensitivity. Higher values make the sensitivity greater.

SCALE TUNE

Parameter	Value	Explanation
Source	SCENE, SYS	Specifies whether scale tune is specified by the scene setting (SCENE) or by the system setting (SYS).
Type (Scale Tune Type)	CUSTOM	Custom: Allows you to specify a custom temperament.
	EQUAL	Equal temperament: This temperament divides the octave into 12 equal parts. Slight inharmonicity is equally present in all intervals.
	JUST-MAJ	Just intonation (major): This temperament produces pure fifths and thirds. It is not suitable for melodic playing and does not allow modulation to another key, but produces beautiful-sounding chords.
	JUST-MIN	Just intonation (minor): Just intonation differs between major and minor. This produces the same effect as “ Just intonation (major) ” but for a minor key.
	PYTHAGORE	Pythagorean temperament: This is based on the theories of the philosopher Pythagoras, and eliminates inharmonicity in the fourth and fifth. Third interval chords are imperfect, but melodies will sound good.
	KIRNBERGE	Kirnberger: This temperament improves meantone temperament and just intonation to allow greater freedom of modulation. It allows performance in all keys (Type III).
	MEANTONE	Meantone temperament: This temperament is a partial compromise of just intonation that allows modulation.
	WERCKMEIS	Werckmeister: This temperament combines meantone temperament and Pythagorean temperament. It allows performance in all keys (Werckmeister I (III)).
	ARABIC	Arabic temperament: This temperament is suitable for Arabic music.
	Key (Scale Tune Key)	C–B
C–B	-64–+63	Finely adjusts the pitch.

ZONE EFFECTS

Settings for zones 1–3 (UP1/UP2/LOW).

* Effect-related settings.

EQ

Parameter	Value	Explanation
Switch	OFF, ON	Switches the equalizer (EQ) on/off.
In Gain (Input Gain)	-24–+24 [dB]	Specifies the amount of boost/cut for the input audio.
Low Gain (Low Gain)	-24–+24 [dB]	Specifies the amount of boost/cut for the low-frequency region.
Low Freq (Low Frequency)	20–16000 [Hz]	Frequency of the low range.
Mid Gain (Mid Gain)	-24–+24 [dB]	Specifies the amount of boost/cut for the mid-frequency region.
Mid Freq (Mid Frequency)	20–16000 [Hz]	Specifies the center frequency of the mid-frequency region.
Mid Q (Mid Q)	0.5–16.0	Specifies the width of the mid-frequency region. Set a higher value for Q to narrow the range to be affected.
High Gain	-24–+24 [dB]	Specifies the amount of boost/cut for the high-frequency region.
HighFreq (High Frequency)	20–16000 [Hz]	Frequency of the high range.

MFX

Parameter	Value	Explanation
FillwToneMFX (Follow Tone MFX)	OFF, ON	Turn this “ON” if you want to use the MFX settings of the tone. If this is “OFF,” you can edit the MFX type and parameters. Press the [Enter] button to enter the MFX Edit screen and edit the MFX parameters. To exit the MFX Edit screen, press the [EXIT] button. If FillwToneMfx is ON, the MFX settings of the tone are used, so you can't change the value. ➔ “MFX/IFX Parameters” (p. 21)
Type (MFX Type)		Selects the MFX type.
Switch	OFF, ON	Turns MFX on/off.
Cho Send (Chorus Send Level)	0–127	Specifies the chorus send level of the sound after MFX is applied. * If FillwToneMfx is ON, the MFX settings of the tone are used, so you can't change the value.
Rev Send (Reverb Send Level)	0–127	Specifies the reverb send level of the sound after MFX is applied. * If FillwToneMfx is ON, the MFX settings of the tone are used, so you can't change the value.

SCENE EFFECTS

Settings for the effects applied to the entire scene.

SYMPATHETIC RESO

These parameters adjust the resonance (sympathetic resonance) that occurs when you hold down the damper pedal. On an acoustic piano, holding down the damper pedal allows strings other than those that you play to resonate sympathetically with the played strings, creating a richly expansive resonance. This effect simulates that behavior.

Parameter	Value	Explanation
Switch	OFF, ON	With the ON setting, the effect is applied.
Depth	0–127	Effect depth
Cabinet Reso	0–127	Depth of the resonance when the damper pedal is not pressed.
Atk LPF	16–15000 [Hz], BYPASS	Frequency of the filter that cuts the high-frequency portion of the input sound. (BYPASS: no cut)
Atk HPF	BYPASS, 16–15000 [Hz]	Frequency of the filter that cuts the low-frequency portion of the input sound. (BYPASS: no cut)
AtkPkg Freq	16–15000 [Hz]	Center frequency of the filter that boosts/cuts the specified region of the input sound.
AtkPkg Gain	-15–+15 [dB]	Amount of boost/cut for the filter that boosts/cuts the specified region of the input sound.
AtkPkg Q	0.5, 1.0, 2.0, 4.0, 8.0	Width of the frequency region boosted/cut by Peaking Gain (higher values make the region narrower).
Rev HF Damp	16–15000 [Hz], BYPASS	Frequency at which the high-frequency portion of the resonance sound is cut. (BYPASS: no cut)
Rev LF Damp	BYPASS, 16–15000 [Hz]	Frequency at which the low-frequency portion of the resonance sound is cut. (BYPASS: no cut)
Aliquot Level	0–127	Adjusts the level of the sound of an acoustic piano's resonating aliquot strings (duplex scaling). Higher values make the resonant sound louder.
Level	0–127	Output Level

IFX

These are settings for the IFX (insertion effect) of which the scene can use one instance.

Parameter	Value	Explanation
Type (IFX Type)		Selects the IFX type. If you press the [Enter] button, you enter the IFX Edit screen where you can edit the IFX parameters. To leave the IFX Edit screen, press the [EXIT] button. * The types and parameters that can be selected are the same for MFX and IFX. ➔ “MFX/IFX Parameters” (p. 21)
Switch	OFF, ON	Turns IFX on/off.
Cho Send (Chorus Send Level)	0–127	Specifies the chorus send level of the sound after MFX is applied.
Rev Send (Reverb Send Level)	0–127	Specifies the reverb send level of the sound after MFX is applied.

CHORUS

These parameters are chorus settings for each scene.

Parameter	Value	Explanation
Source	SCENE, SYS	Specifies whether the chorus settings follow the settings of the scene (SCENE) or the system settings (SYS).
Type (Chorus Type)	If Source is "SCENE," you can edit the chorus type and the other parameters. In the chorus type page, press the [Enter] button to enter the chorus parameter page. ➔ "CHORUS Parameter" (p. 10)	
Switch	OFF, ON	Turns chorus on/off.
Level (Chorus Level)	0–127	Specifies the output level of the sound to which chorus is applied.
Rev Send (Reverb Send)	0–127	Specifies the send level to reverb.

CHORUS Parameter

Chorus

This is a stereo chorus.

Parameter	Value	Explanation
Rate	0–127	Adjusts the rate of modulation.
Depth	0–127	Adjusts the depth of modulation.
Feedback	0–127	Adjusts the level of the chorus sound that is returned to the input.

CE-1

This models the classic CE-1 chorus effect unit made by BOSS in years past. It produces a chorus sound with distinctive analog warmth.

Parameter	Value	Explanation
Intensity	0–127	Adjusts the depth of chorus.

SDD-320

This models Roland's DIMENSION D (SDD-320). It provides a clear chorus sound.

Parameter	Value	Explanation
Mode	1–4, 1+4, 2+4, 3+4	Switches the mode.

Delay

This is a stereo delay.

Parameter	Value	Explanation
Dly Sync (sync sw)	OFF, ON	If this is ON, the delay is synchronized to the tempo.
Dly Msec (msec) Dly Note (note)	1–1300 [msec] Note ➔ "Note" (p. 64)	Adjusts the delay time from the original sound until the delay sound is heard.
Feedback	-98–+98 [%]	Adjusts the proportion at which the delay sound is returned to the input (negative values: reverse phase).
HF Damp	200–8000 [Hz], BYPASS	Adjusts the frequency above which the high-frequency portion of the delay sound returned to the input is cut (BYPASS: no cut).

T-Ctrl Dly

A stereo delay in which the delay time can be varied smoothly.

Parameter	Value	Explanation
Dly Sync (sync sw)	OFF, ON	If this is on, the delay is synchronized to the tempo.
Dly Msec (msec) Dly Note (note)	1–1300 [msec] Note ➔ "Note" (p. 64)	Adjusts the delay time from the original sound until the delay sound is heard.
Acceleration	0–15	Adjusts the duration between when you vary the delay time until it changes from the current delay time to the specified delay time. The speed of pitch change also changes with the delay time.
Feedback	-98–+98 [%]	Adjusts the proportion at which the delay sound is returned to the input (negative values: reverse phase).
HF Damp	200–8000 [Hz], BYPASS	Adjusts the frequency above which the high-frequency portion of the delay sound returned to the input is cut (BYPASS: no cut).

Delay → Trem

This applies tremolo to the delay sound.

Parameter	Value	Explanation
Input	MONAURAL	Mixes the input to mono.
	STEREO	Inputs in stereo.
Dly Sync (sync sw)	OFF, ON	If this is on, the delay is synchronized to the tempo.
Dly Msec (msec) Dly Note (note)	1–1300 [msec] Note ➔ "Note" (p. 64)	Adjusts the delay time from the original sound until the delay sound is heard.
Feedback	-98–+98 [%]	Adjusts the proportion at which the delay sound is returned to the input (negative values: reverse phase).
HF Damp	200–8000 [Hz], BYPASS	Adjusts the frequency above which the high-frequency portion of the delay sound returned to the input is cut (BYPASS: no cut).
Trm Switch	OFF, ON	Turns the tremolo effect on/off.
Trm ModWave	Modulation Wave	
	TRI	Triangle wave
	SQR	Square wave
	SIN	Sine wave
	SAW1	Sawtooth wave
	SAW2	
TRP	Trapezoid wave	
Trm Sync (sync sw)	OFF, ON	If this is ON, the tremolo is synchronized to the tempo.
Trm Hz (Hz) Trm Note (note)	0.05–10.00 [Hz] Note ➔ "Note" (p. 64)	Adjusts the rate at which tremolo is applied.
Trm Depth	0–127	Adjusts the depth to which tremolo is applied.

2Tap PanDly

This produces delay sound in the two directions that you specify.

Parameter	Value	Explanation
Dly Sync (sync sw)	OFF, ON	If this is on, the delay is synchronized to the tempo.
Dly Msec (msec)	1–1300 [msec]	Adjusts the delay time from the original sound until the second delay sound is heard.
Dly Note (note)	Note ➔ "Note" (p. 64)	
Feedback	-98–+98 [%]	Adjusts the proportion at which the delay sound is returned to the input (negative values: reverse phase).
HF Damp	200–8000 [Hz], BYPASS	Adjusts the frequency above which the high-frequency portion of the delay sound returned to the input is cut (BYPASS: no cut).
Dly 1 Pan	L64–63R	Adjusts the panning of delay 1.
Dly 2 Pan	L64–63R	Adjusts the panning of delay 2.
Dly 1 Level	0–127	Adjusts the volume of delay 1.
Dly 2 Level	0–127	Adjusts the volume of delay 2.

3Tap PanDly

This produces delay sound in the three directions that you specify.

Parameter	Value	Explanation
Dly Sync (sync sw)	OFF, ON	If this is on, the delay is synchronized to the tempo.
Dly Msec (msec)	1–2600 [msec]	Adjusts the delay time from the original sound until the third delay sound is heard.
Dly Note (note)	Note ➔ "Note" (p. 64)	
Feedback	-98–+98 [%]	Adjusts the proportion at which the delay sound is returned to the input (negative values: reverse phase).
HF Damp	200–8000 [Hz], BYPASS	Adjusts the frequency above which the high-frequency portion of the delay sound returned to the input is cut (BYPASS: no cut).
Dly 1 Pan	L64–63R	Adjusts the panning of delay 1.
Dly 2 Pan	L64–63R	Adjusts the panning of delay 2.
Dly 3 Pan	L64–63R	Adjusts the panning of delay 3.
Dly 1 Level	0–127	Adjusts the volume of delay 1.
Dly 2 Level	0–127	Adjusts the volume of delay 2.
Dly 3 Level	0–127	Adjusts the volume of delay 3.

JUNO Chorus

This models the chorus section of the Roland JUNO-106.

Parameter	Value	Explanation
Mode	I, II, I+II, JX I, JX II	Selects the type of chorus. I+II: The state when the two buttons are pressed simultaneously.
Noise Level	0–127	Adjusts the volume of the noise that is produced by the chorus.

REVERB

These are reverb settings for each scene.

Parameter	Value	Explanation
Source	SCENE, SYS	Specifies whether the reverb settings follow the settings of the scene (SCENE) or the system settings (SYS).
Type (Reverb Type)		If Source is "SCENE," you can edit the reverb type and parameters. In the reverb type page, press the [Enter] button to enter the reverb parameter page. ➔ "REVERB Parameter" (p. 11)
Switch	OFF, ON	Turns the reverb on/off.
Level (Reverb Level)	0–127	Specifies the output level of the sound to which reverb is applied.

REVERB Parameter

INTEGRA7Rev

Parameter	Value	Explanation
Char	01: ROOM1 02: ROOM2 03: HALL1 04: HALL2 05: PLATE	Type of reverb OFF: Reverb is not used Room 1/2: Room Hall 1/2: Hall Plate: Plate
Pre Delay	0–100 [msec]	Adjusts the delay time from the original sound until the reverb sound is heard.
Time	0.1–10.0 [sec]	Adjusts the length of time over which the reverb sound decays.
Density	0–127	Adjusts the density of the reverb sound.
Diffusion	0–127	With higher values of this parameter, the density of the reverb sound increases as time passes. (The effect of this setting is most pronounced with long reverb times.)
LF Damp	0–100	Adjusts the low-frequency portion of the reverb.
HF Damp	0–100	Adjusts the high-frequency portion of the reverb.
Spread	0–127	Adjusts the spread of the reverb sound.
Tone	0–127	Adjusts the tonal character of the reverb sound.

Scene Parameter

Warm Hall

Parameter	Value	Explanation
Pre Delay	0–100 [msec]	Adjusts the delay time from the original sound until the reverb sound is heard.
Time	0.3–30.0 [sec]	Adjusts the length of time over which the reverb sound decays.
Pre LPF	16–15000 [Hz], BYPASS	Adjusts the frequency above which the high-frequency portion of the sound being input to the reverb is cut.
Pre HPF	16–15000 [Hz], BYPASS	Adjusts the frequency below which the low-frequency portion of the sound being input to the reverb is cut.
PreLpLPF	16–15000 [Hz], BYPASS	Adjusts the frequency above which the high-frequency portion of the long reverb sound is cut.
Diffusion	0–127	Adjusts the time-varying change in the density of the reverb sound.
HF Damp F	1000–8000 [Hz]	Adjusts the frequency above which the high-frequency portion of the reverb sound is cut.
HF Damp R	0.1–1.0	Adjusts the amount of attenuation for the high-frequency portion of the reverb sound.

Hall

Parameter	Value	Explanation
Pre Delay	0.0–100.0 [msec]	Adjusts the delay time from the original sound until the reverb sound is heard.
Time	0–127	Adjusts the length of time over which the reverb sound decays.
Size	1–8	Adjusts the size of the room or hall.
High Cut	160–12500 [Hz], BYPASS	Adjusts the frequency above which the high-frequency portion of the final output sound is cut (BYPASS: no cut).
Density	0–127	Adjusts the density of the reverb sound.
Diffusion	0–127	With higher values of this parameter, the density of the reverb sound increases as time passes. (The effect of this setting is most pronounced with long reverb times.)
LF Damp F	50–4000 [Hz]	Adjusts the frequency below which the low-frequency portion of the reverb sound is cut.
LF Damp G	-36–0 [dB]	Adjusts the amount of attenuation for LF damp (0: no effect).
HF Damp F	4000–12500 [Hz]	Adjusts the frequency above which the high-frequency portion of the reverb sound is cut.
HF Damp G	-36–0 [dB]	Adjusts the amount of attenuation for HF damp (0: no effect).

GS Reverb

Parameter	Value	Explanation
Char	ROOM1–3, HALL1–2, PLATE, DELAY, PAN-DELAY	Selects the type of reverb.
Pre LPF	0–7	Adjusts the amount of attenuation for the high-frequency portion of the sound being input to the reverb.
Time	0–127	Adjusts the length of time over which the reverb sound decays.
Feedback	0–127	Adjusts the level at which the reverb sound is returned to the input.

SRV-2000

Parameter	Value	Explanation
Selection	Selects the type of reverb produced by the Roland SRV-2000 digital reverb unit.	
	R0.3–R37	Room reverb. Higher values increase the size of the room.
	H15–H37	Hall reverb. Higher values increase the size of the concert hall.
	P-B	Plate reverb. This is a more flamboyant reverb sound than P-A.
	P-A	Plate reverb.
Pre Delay	0–160	Adjusts the delay time from the original sound until the reverb sound is heard.
Time	0.1s–99.0s [msec]	Adjusts the length of time over which the reverb sound decays.
HF Damp	0.05–1.00	Adjusts the high-frequency portion of the reverb.
Density	0–9	Adjusts the density of the late reverberation.
Attack Gain	0–9	Adjusts the gain of the early reflections.
Attack Time	0–9	Adjusts the time of the early reflections.
ER Density	0–9	Adjusts the density of the early reflections.
ER Level	0–99	Adjusts the volume of the early reflections.
Low Freq	0.04–1.00 [kHz]	Frequency of the low range.
Low Gain	-24–+12 [dB]	Gain of the low frequency range.
Mid Freq	0.25–9.99 [kHz]	Specifies the center frequency of the mid-frequency region.
Mid Gain	-24–+12 [dB]	Adjusts the boost/cut of the mid-frequency range.
Mid Q	0.2–9.0	Specifies the bandwidth of the mid-frequency range. Set a higher value for Q to narrow the range to be affected.
High Freq	0.80–9.99 [kHz]	Frequency of the high range.
High Gain	-24–+12 [dB]	Gain of the high frequency range.
HIGH Q	0.2–9.0	Specifies the bandwidth of the high-frequency range. Set a higher value for Q to narrow the range to be affected.

SRV-2000NL (NON-LINEAR)

Parameter	Value	Explanation
PreDelay	0–120	Adjusts the delay time from the original sound until the reverb sound is heard.
ReverbTime	-0.9–+99.0 [sec]	Adjusts the length of time over which the reverb sound decays.
GateTime	10–450	Adjusts the length of time over which the reverb sound decays.
Low Freq	0.04–1.00 [kHz]	Frequency of the low range.
Low Gain	-24–+12 [dB]	Gain of the low frequency range.
Mid Freq	0.25–9.99 [kHz]	Specifies the center frequency of the mid-frequency region.
Mid Gain	-24–+12 [dB]	Adjusts the boost/cut of the mid-frequency range.
Mid Q	0.2–9.0	Specifies the bandwidth of the mid-frequency range. Set a higher value for Q to narrow the range to be affected.
HighFreq	0.80–9.99 [kHz]	Frequency of the high range.
HighGain	-24–+12 [dB]	Gain of the high frequency range.
Hi Q	0.2–9.0	Specifies the bandwidth of the high-frequency range. Set a higher value for Q to narrow the range to be affected.

GM2 Reverb

Parameter	Value	Explanation
Char	SMALL ROOM MEDIUM ROOM LARGE ROOM MEDIUM HALL LARGE HALL PLATE	Selects the type of reverb.
Pre LPF	0–7	Adjusts the amount of attenuation for the high-frequency portion of the sound being input to the reverb.
Time	0–127	Adjusts the length of time over which the reverb sound decays.

SYSTEM EFFECTS Parameter

Here's how to edit the settings of the currently selected system effects.

1. Press the [MENU] button.
2. Use the cursor [^] [v] buttons to select "SYSTEM EFFECT," and then press the [ENTER] button.
3. Use the cursor [<] [>] buttons to select the effect that you want to edit, use the cursor [^] [v] buttons to select a parameter, and use the [DEC] [INC] buttons to edit the value.

SYS CHORUS

These are settings for the chorus effect that is applied to the entire system.

Parameter	Value	Explanation
Type	Selects the type of chorus. When you press the [Enter] button, the parameters for the selected type of chorus are shown.	
Switch	OFF, ON	Turns chorus on/off.
Level	0-127	Specifies the output level of the sound to which chorus is applied.
CHORUS Parameter	Specifies the parameters of the selected type of chorus. The available parameters differ depending on the type of chorus selected in Type. ➔ "CHORUS Parameter" (p. 10)	

SYS REVERB

These are settings for the reverb that is applied to the entire system.

Parameter	Value	Explanation
Type	Type of reverb When you press the [Enter] button, the parameters for the selected type of reverb are shown.	
Switch	OFF, ON	Turns the reverb on/off.
Level	0-127	Specifies the output level of the sound to which reverb is applied.
REVERB Parameter	Specifies the parameters of the selected type of reverb. The available parameters differ depending on the type of reverb selected in Type. ➔ "REVERB Parameter" (p. 11)	

MASTER EQ

These are settings for the EQ that is applied to the entire system.

Parameter	Value	Explanation
Switch	OFF, ON	Specifies whether the master EQ (an equalizer applied to the entire sound engine of the RD-88) is used (ON) or not used (OFF).
In Gain	-24+24 [dB]	Adjusts the amount of boost/cut for the input to the EQ.
Low Gain	-24+24 [dB]	Gain of the low frequency range.
Low Freq	20-16000 [Hz]	Frequency of the low range.
Mid1 Gain	-24+24 [dB]	Gain of the middle frequency range 1.
Mid1 Freq	20-16000 [Hz]	Frequency of the middle range 1.
Mid1 Q	0.5-16.0	Specifies the bandwidth of middle frequency range 1. Higher values make the bandwidth narrower.
Mid2 Gain	-24+24 [dB]	Gain of the middle frequency range 2.
Mid2 Freq	20-16000 [Hz]	Frequency of the middle range 2.
Mid2 Q	0.5-16.0	Specifies the bandwidth of middle frequency range 2. Higher values make the bandwidth narrower.
Mid3 Gain	-24+24 [dB]	Gain of the middle frequency range 3.
Mid3 Freq	20-16000 [Hz]	Frequency of the middle range 3.
Mid3 Q	0.5-16.0	Specifies the bandwidth of middle frequency range 3. Higher values make the bandwidth narrower.
High Gain	-24+24 [dB]	Gain of the high frequency range.
High Freq	20-16000 [Hz]	Frequency of the high range.

MASTER COMP

These are settings for the compressor that is applied to the entire system.

Parameter	Value	Explanation
Switch	OFF, ON	Specifies whether the master compressor (a compressor that is applied to the entire sound engine of the RD-88) is used (ON) or not used (OFF).
Split Low	16–16000 [Hz]	Specifies the frequency that separates the low-frequency (LOW) and mid-frequency (MID) regions.
Split High		Specifies the frequency that separates the high-frequency (HIGH) and mid-frequency (MID) regions.
Low Attack	0.1–100 [ms]	Specifies the time from when input exceeds the Low Thres setting until the volume of the low-frequency region is compressed.
Low Rels	10–1000 [ms]	From a state in which compression is applied, this specifies the time after the input falls below the Low Thresh until the low-frequency region is no longer compressed.
Low Thres	-60–0 [dB]	Specifies the volume level at which compression of the low-frequency region begins.
Low Ratio	1: 1, 2: 1, 3: 1, 4: 1, 8: 1, 16: 1, 32: 1, INF: 1	Specifies the compression ratio for the low-frequency region.
Low Knee	0–30 [dB]	This is a function that smooths the onset of compression from the uncompressed state; it gradually applies compression starting earlier than Low Thres. Higher values produce a smoother transition.
Low Gain	-24.0–+24.0 [dB]	Specifies the output volume of the low-frequency region.
Mid Attack	0.1–100 [ms]	Specifies the time from when input exceeds the Mid Thres setting until the volume of the mid-frequency region is compressed.
Mid Rels	10–1000 [ms]	From a state in which compression is applied, this specifies the time after the input falls below the Mid Thresh setting until the mid-frequency region is no longer compressed.
Mid Thres	-60–0 [dB]	Specifies the volume level at which compression of the mid-frequency region begins.
Mid Ratio	1: 1, 2: 1, 3: 1, 4: 1, 8: 1, 16: 1, 32: 1, INF: 1	Specifies the compression ratio for the mid-frequency region.
Mid Knee	0–30 [dB]	This is a function that smooths the onset of compression from the uncompressed state; it gradually applies compression starting earlier than Mid Thres. Higher values produce a smoother transition.
Mid Gain	-24.0–+24.0 [dB]	Specifies the output volume of the mid-frequency region.
High Attack	0.1–100 [ms]	Specifies the time from when input exceeds the High Thres setting until the volume of the high-frequency region is compressed.
High Rels	10–1000 [ms]	From a state in which compression is applied, this specifies the time after the input falls below the High Thresh setting until the high-frequency region is no longer compressed.
High Thres	-60–0 [dB]	Specifies the volume level at which compression of the high-frequency region begins.

Parameter	Value	Explanation
High Ratio	1: 1, 2: 1, 3: 1, 4: 1, 8: 1, 16: 1, 32: 1, INF: 1	Specifies the compression ratio for the high-frequency region.
High Knee	0–30 [dB]	This is a function that smooths the onset of compression from the uncompressed state; it gradually applies compression starting earlier than High Thres. Higher values produce a smoother transition.
High Gain	-24.0–+24.0 [dB]	Specifies the output volume of the high-frequency region.

SYSTEM Parameter

Here you can edit the parameters that apply to the entire RD-88.

1. Press the [MENU] button.
2. Use the cursor [▲] [▼] buttons to select "SYSTEM," and then press the [ENTER] button.
3. Use the cursor [▲] [▼] buttons to select the item that you want to edit, and press the [ENTER] button.
4. Use the cursor [▲] [▼] buttons to select the parameter that you want to edit, and use the [DEC] [INC] buttons to edit the value.

GENERAL

Parameter	Value	Explanation
MasterTune (Master Tune)	415.3–466.2 [Hz]	Tunes the entire unit. The displayed value is the frequency of the A4 key (middle A).
MasKeyShift (Master Key Shift)	-24–+24	Shifts the RD-88's overall pitch range in semitone steps.
Tempo (Tempo)	20–250	Specifies the system tempo.
Tempo Src (Tempo Source)	SCENE, SYS	Specifies whether, when you switch scenes, the system tempo is used (SYS) or the tempo memorized in the scene is used (SCENE).
Rhy Ptn Level (Rhythm Pattern Level)	0–127	Adjusts the volume of the rhythm pattern.
Song Level (Song Player Level)	0–127	Adjusts the volume of the song on the USB flash drive.
Out Gain (Output Gain)	-12–+12 [dB]	Adjusts the output gain.
Auto Off (Auto Off)	OFF, 30 [min], 240 [min]	Specifies a fixed time after which the power turns off automatically. If you don't want the power to turn off automatically, choose the "OFF" setting.
LCD Contrast (LCD Contrast)	1–10	Adjusts the contrast of the display.
USB Driver (USB Driver)	GENERIC	Choose this if you want to use the standard USB driver that was included with your computer.
	VENDOR	Choose this if you want to use a USB driver downloaded from the Roland website.
DamperPole (Damper Pedal Polarity)	STANDARD, REVERSE	Specifies the polarity of the pedal connected to the Damper Pedal jack.

KEY TOUCH

These are settings related to keyboard touch (for the entire system).

Parameter	Value	Explanation
Velo Crv	SPR LIGHT	An even lighter setting than LIGHT.
	LIGHT	Specifies a light keyboard touch response. Since you can produce fortissimo (ff) using an even lighter touch than with the MEDIUM setting, this feels as though the keyboard is lighter. This setting is easy to play even by those whose hands have less strength.
	MEDIUM	Specifies the standard keyboard touch response. This allows playing with the most natural touch. This is closest to the touch of an acoustic piano.
	HEAVY	Specifies a heavy keyboard touch response. Since producing fortissimo (ff) requires you to play with a stronger touch than with the MEDIUM setting, this feels as though the keyboard is heavier. This setting allows even greater expressiveness when you play dynamically.
	SPR HEAVY	An even heavier setting than HEAVY.
Velo Offset	-10–+9	Finely adjusts the keyboard touch response in greater detail than the Velocity Curve setting. This lets you specify detailed settings between the various Velocity Curve values. Higher values make the touch feel heavier. If this value exceeds the upper or lower limit, the Velocity Curve also switches automatically between its five values as appropriate.
Velocity	REAL,	The volume and character of the sound responds to your keyboard playing dynamics.
	1–127	The volume and character of the sound remains fixed regardless of your keyboard playing dynamics.
Velo Dly Sens	-63–+63	Specifies the delay from the moment you press the key until the sound is heard. Negative values delay the timing at which the sound is heard when you press the key strongly. Positive values delay the timing at which the sound is heard when you press the key softly.
Velo Keyfollow	-63–+63	Specifies how keyboard touch is affected by the keyboard range. With higher values, the keyboard feels heavier as you play upward and lighter as you play downward.
KeyOff Pos	STANDARD	Note-off occurs at the same key depth as a conventional piano.
	DEEP	Note-off occurs at a deeper key depth. This is appropriate for sounds such as electric piano.

ASSIGN

These settings specify the functions that are assigned to the various jacks (for the entire system).

PEDAL

Parameter	Value	Explanation
FC1 (FC1 Function)	OFF	No function is assigned.
	CC01–31, 32(OFF), 33–95	Controller number 1–31, 32, 33–95
	AFT	Aftertouch
	BEND DOWN	Lower the pitch.
	BEND UP	Raise the pitch.
	SCENE DOWN	Switch the scene to the previous number.
	SCENE UP	Switch the scene to the next number.
	START/STOP	Play/stop the rhythm or audio file.
FC1 Pole (FC1 Pedal Polarity)	STANDARD, REVERSE	Specifies the polarity of the pedal that is connected to the FC1 PEDAL jack.
FC2 (FC2 Function)	OFF	No function is assigned.
	CC01–31, 32(OFF), 33–95	Controller number 1–31, 32, 33–95
	AFT	Aftertouch
	BEND DOWN	Lower the pitch.
	BEND UP	Raise the pitch.
	SCENE DOWN	Switch the scene to the previous number.
	SCENE UP	Switch the scene to the next number.
	START/STOP	Play/stop the rhythm or audio file.
FC2 Pole (FC2 Pedal Polarity)	STANDARD, REVERSE	Specifies the polarity of the pedal that is connected to the FC2 PEDAL jack.

WHEEL

Parameter	Value	Explanation
Wheel1 (Wheel1 Function)	OFF	No function is assigned.
	CC01–31, 32(OFF), 33–95	Controller number 1–31, 32, 33–95
	AFT	Aftertouch
	PITCH BEND	Raise or lower the pitch.
Wheel2 (Wheel2 Function)	OFF	No function is assigned.
	CC01–31, 32(OFF), 33–95	Controller number 1–31, 32, 33–95
	AFT	Aftertouch
	BEND DOWN	Lower the pitch.
	BEND UP	Raise the pitch.

KNOB

Parameter	Value	Explanation
Knob1–Knob8 Knob1 Function–Knob 8 Function	OFF	No function is assigned.
	CC01–31, 32(OFF), 33–95	Controller number 1–31, 32, 33–95
	AFT	Aftertouch
	BEND DOWN	Lower the pitch.
	BEND UP	Raise the pitch.

MIDI

GENERAL

Parameter	Value	Explanation
Ctrl Ch	1–16, OFF	Specifies the MIDI receive channel that is used when an external MIDI device transmits MIDI messages (program change / bank select) to switch scenes. If you don't want to switch RD-88 scenes from a connected MIDI device, turn this "OFF" .
Ctrl Src Sel	SYS	The system settings for CtrlSrc1–4 are used for tone control.
	SCENE	The scene settings for CtrlSrc1–4 are used for tone control.
SysCtrlSrc1–4	OFF, CC01–CC31, CC33–CC95, BEND, AFT	Specifies the MIDI messages that are used for system control. System control settings specify the MIDI messages used by the entire RD-88 system to control the volume and tonal character. You can specify up to four MIDI messages for control use.
USB-MIDIThru	OFF, ON	Specifies whether MIDI messages received from the USB COMPUTER port are transmitted without change from the MIDI OUT connector and USB COMPUTER port (ON) or not transmitted (OFF).
Remote Kbd	OFF, ON	Turn this "ON" if you are using an external MIDI keyboard instead of the keyboard of the RD-88. In this case, the MIDI transmit channel of the external MIDI keyboard can be any channel. Normally you will leave this "OFF" .
Device ID	17–32	When transmitting and receiving system exclusive messages, the device ID numbers of both devices must match.

MIDI TX

Parameter	Value	Explanation
Tx PC	OFF, ON	Specifies whether program change messages are transmitted (ON) or not transmitted (OFF).
Tx Bank	OFF, ON	Specifies whether bank select messages are transmitted (ON) or not transmitted (OFF).
Tx Edit	OFF, ON	Specifies whether edits for scene settings are transmitted as system exclusive messages (ON) or not transmitted (OFF).

MIDI RX

Parameter	Value	Explanation
Rx PC	OFF, ON	Specifies whether program change messages are received (ON) or not received (OFF).
Rx Bank	OFF, ON	Specifies whether bank select messages are received (ON) or not received (OFF).
Rx Exclusive	OFF, ON	Specifies whether system exclusive messages are received (ON) or not received (OFF).

LOCAL SW

Parameter	Value	Explanation
Local Sw	OFF, ON	Specifies whether the keyboard of the RD-88 will play the internal sound engine (ON) or will not play it (OFF). Turn this OFF if you want to play only an external MIDI device.

USB AUDIO

Parameter	Value	Explanation
Audio In Level	0–127	Adjusts the input level of USB audio.
Audio Out Level	0–127	Adjusts the output level of USB audio.
Audio Out Src	MIX, INPUT	Specify “INPUT” if you want the USB audio output to output only the audio of the LINE/MIC input. If this is set to “MIX,” the audio from both the RD-88 itself and from the LINE/MIC input is output via USB audio.
Audio Thru	OFF, ON	Specifies whether the input from USB audio is sent through to USB audio output (ON) or not sent through (OFF). * If this is set to “ON,” take care that an audio loop does not occur on your PC (DAW).

SCALE TUNE

Parameter	Value	Explanation
Type (Scale Tune Type)	CUSTOM	Custom: Allows you to specify a custom temperament.
	EQUAL	Equal temperament: This temperament divides the octave into 12 equal parts. Slight inharmonicity is equally present in all intervals.
	JUST-MAJ	Just intonation (major): This temperament produces pure fifths and thirds. It is not suitable for melodic playing and does not allow modulation to another key, but produces beautiful-sounding chords.
	JUST-MIN	Just intonation (minor): Just intonation differs between major and minor. This produces the same effect as “Just intonation (major)” but for a minor key.
	PYTHAGORE	Pythagorean temperament: This is based on the theories of the philosopher Pythagoras, and eliminates inharmonicity in the fourth and fifth. Third interval chords are imperfect, but melodies will sound good.
	KIRNBERGE	Kirnberger: This temperament improves meantone temperament and just intonation to allow greater freedom of modulation. It allows performance in all keys (Type III).
	MEANTONE	Meantone temperament: This temperament is a partial compromise of just intonation that allows modulation.
	WERCKMEIS	Werckmeister: This temperament combines meantone temperament and Pythagorean temperament. It allows performance in all keys (Werckmeister I (III)).
ARABIC	Arabic temperament: This temperament is suitable for Arabic music.	
Key (Scale Tune Key)	C–B	Sets the keynote.
C–B	-64–+63	Finely adjusts the pitch.

INPUT SETTING

These are settings for LINE/MIC Input.

GENERAL

Parameter	Value	Explanation
Input Level	0-127	Adjusts the level of the LINE/MIC input.
Mic Att Sw	OFF, ON	Turn this ON if you want to lower the mic input gain. If the mic input is distorted, turn this ON and adjust the Input Level.

INPUT REVERB

These are settings for the input reverb.

Parameter	Value	Explanation
Type	Type of reverb When you press the [Enter] button, the parameters for the selected type of reverb are shown. → "REVERB Parameter" (p. 11)	
Switch	OFF, ON	Turns on/off the reverb for the LINE/MIC input.
Level	0-127	Adjusts the reverb level.

INPUT EQ

These are settings for the input EQ.

Parameter	Value	Explanation
Switch	OFF, ON	Specifies whether the master EQ (an equalizer applied to the entire sound engine of the RD-88) is used (ON) or not used (OFF).
In Gain	-24+24 [dB]	Adjusts the amount of boost/cut for the input to the EQ.
Low Gain	-24+24 [dB]	Gain of the low frequency range.
Low Freq	20-16000 [Hz]	Frequency of the low range.
Mid1 Gain	-24+24 [dB]	Gain of the middle frequency range 1.
Mid1 Freq	20-16000 [Hz]	Frequency of the middle range 1.
Mid1 Q	0.5-16.0	Specifies the bandwidth of middle frequency range 1. Higher values make the bandwidth narrower.
Mid2 Gain	-24+24 [dB]	Gain of the middle frequency range 2.
Mid2 Freq	20-16000 [Hz]	Frequency of the middle range 2.
Mid2 Q	0.5-16.0	Specifies the bandwidth of middle frequency range 2. Higher values make the bandwidth narrower.
Mid3 Gain	-24+24 [dB]	Gain of the middle frequency range 3.
Mid3 Freq	20-16000 [Hz]	Frequency of the middle range 3.
Mid3 Q	0.5-16.0	Specifies the bandwidth of middle frequency range 3. Higher values make the bandwidth narrower.
High Gain	-24+24 [dB]	Gain of the high frequency range.
High Freq	20-16000 [Hz]	Frequency of the high range.

MFX/IFX Parameters

MFX/IFX provides 79 different effect types.

Some of the effect types connect two or more types of effect in series.

Thru

L in → L out

R in → R out

Equalizer

This is a four-band stereo equalizer (low, mid x 2, high).

L in → 4-Band EQ → L out

R in → 4-Band EQ → R out

Parameter	Value	Explanation
Low Freq (Low Frequency)	20, 25, 31, 40, 50, 63, 80, 100, 125, 160, 200, 250, 315, 400 [Hz]	Frequency of the low range
Low Gain	-15--+15 [dB]	Amount of boost/cut for the low-frequency range
Mid1 Freq (Mid1 Frequency)	200, 250, 315, 400, 500, 630, 800, 1000, 1250, 1600, 2000, 2500, 3150, 4000, 5000, 6300, 8000 [Hz]	Frequency of the middle range 1
Mid1 Gain	-15--+15 [dB]	Gain of the middle range 1
Mid1 Q	0.5, 1.0, 2.0, 4.0, 8.0	Width of the middle range 1 Set a higher value for Q to narrow the range to be affected.
Mid2 Freq (Mid2 Frequency)	200, 250, 315, 400, 500, 630, 800, 1000, 1250, 1600, 2000, 2500, 3150, 4000, 5000, 6300, 8000 [Hz]	Frequency of the middle range 2
Mid2 Gain	-15--+15 [dB]	Gain of the middle range 2
Mid2 Q	0.5, 1.0, 2.0, 4.0, 8.0	Width of the middle range 2 Set a higher value for Q to narrow the range to be affected.
High Freq (High Frequency)	2000, 2500, 3150, 4000, 5000, 6300, 8000, 10000, 12500, 16000 [Hz]	Frequency of the high range
High Gain	-15--+15 [dB]	Amount of boost/cut for the high-frequency range
Level	0-127	Output Level

Spectrum

This is a stereo spectrum. Spectrum is a type of filter which modifies the timbre by boosting or cutting the level at specific frequencies.

L in → Spectrum → L out

R in → Spectrum → R out

Parameter	Value	Explanation
Band1 (Band1 (250 Hz))	-15--+15 [dB]	Gain of each frequency band
Band2 (Band2 (500 Hz))		
Band3 (Band3 (1000 Hz))		
Band4 (Band4 (1250 Hz))		
Band5 (Band5 (2000 Hz))		
Band6 (Band6 (3150 Hz))		
Band7 (Band7 (4000 Hz))		
Band8 (Band8 (8000 Hz))		
Q	0.5, 1.0, 2.0, 4.0, 8.0	Simultaneously adjusts the width of the adjusted ranges for all the frequency bands.
Level	0-127	Output Level

Isolator

This is an equalizer which cuts the volume greatly, allowing you to add a special effect to the sound by cutting the volume in varying ranges.

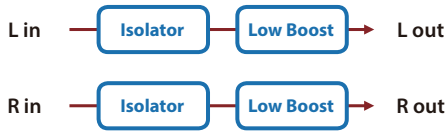

Parameter	Value	Explanation
Low Level (Boost/Cut Low)	-60~+4 [dB]	These boost and cut each of the High, Middle, and Low frequency ranges. At -60 dB, the sound becomes inaudible. 0 dB is equivalent to the input level of the sound.
Mid Level (Boost/Cut Mid)	-60~+4 [dB]	
High Level (Boost/Cut High)	-60~+4 [dB]	
Low AP Sw (Anti Phase Low Switch)	OFF, ON	Turns the Anti-Phase function on and off for the Low frequency ranges. When turned on, the counter-channel of stereo sound is inverted and added to the signal.
Low AP Lv (Anti Phase Low Level)	0-127	Adjusts the level settings for the Low frequency ranges. Adjusting this level for certain frequencies allows you to lend emphasis to specific parts (This is effective only for stereo source.).
Mid AP Sw (Anti Phase Mid Switch)	OFF, ON	Settings of the Anti-Phase function for the Middle frequency ranges. The parameters are the same as for the Low frequency ranges.
Mid AP Lv (Anti Phase Mid Level)	0-127	
Boost Sw (Low Boost Switch)	OFF, ON	Turns Low Booster on/off. This emphasizes the bottom to create a heavy bass sound.
Boost Lv (Low Boost Level)	0-127	Increasing this value gives you a heavier low end. Depending on the Isolator and filter settings this effect may be hard to distinguish.
Level	0-127	Output Level

Low Boost

Boosts the volume of the lower range, creating powerful lows.

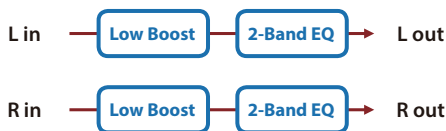

Parameter	Value	Explanation
Boost Freq (Boost Frequency)	50, 56, 63, 71, 80, 90, 100, 112, 125 [Hz]	Center frequency at which the lower range will be boosted
Boost Gain	0~+12 [dB]	Center frequency at which the lower range will be boosted
Boost Wid (Boost Width)	WIDE, MID, NARROW	Width of the lower range that will be boosted
Low Gain	-15~+15 [dB]	Amount of boost/cut for the low-frequency range
High Gain	-15~+15 [dB]	Amount of boost/cut for the high-frequency range
Level	0-127	Output Level

SuperFilter

This is a filter with an extremely sharp slope. The cutoff frequency can be varied cyclically.

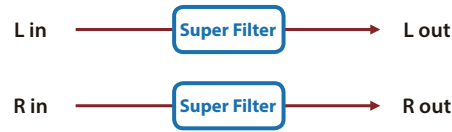

Parameter	Value	Explanation
Type (Filter Type)	LPF, BPF, HPF, NOTCH	Type of filter Frequency range that will pass through each filter LPF: Frequencies below the cutoff BPF: Frequencies in the region of the cutoff HPF: Frequencies above the cutoff NOTCH: Frequencies other than the region of the cutoff
Slope (Filter Slope)	-12, -24, -36 [dB]	Amount of attenuation per octave -12 dB: Gentle, -24 dB: Steep, -36 dB: Extremely steep
Cutoff (Filter Cutoff)	0-127	Cutoff frequency of the filter Increasing this value will raise the cutoff frequency.
Resonance (Filter Resonance)	0-100	Filter resonance level Increasing this value will emphasize the region near the cutoff frequency.
Gain (Filter Gain)	0~+12 [dB]	Amount of boost for the filter output
Mod Sw (Modulation Switch)	OFF, ON	On/off switch for cyclic change
Mod Wave (Modulation Wave)	TRI, SQR, SIN, SAW1, SAW2	How the cutoff frequency will be modulated TRI : Triangle wave SQR : Square wave SIN : Sine wave SAW1: Sawtooth wave (upward) SAW2: Sawtooth wave (downward)
	SAW1 SAW2	
Rate Sync (Rate (sync switch))	OFF, ON	If this is ON, the rate synchronizes with the tempo of the rhythm. ➔ "Tempo" (p. 16)
Rate (Rate (Hz))	0.05-10.00 [Hz]	Frequency of modulation
Rate Note (Rate (note))	Note ➔ "Note" (p. 64)	
Depth	0-127	Depth of modulation
Attack	0-127	Speed at which the cutoff frequency will change This is effective if Modulation Wave is SQR, SAW1, or SAW2.
Level	0-127	Output Level

Step Filter

This is a filter whose cutoff frequency can be modulated in steps. You can specify the pattern by which the cutoff frequency will change.

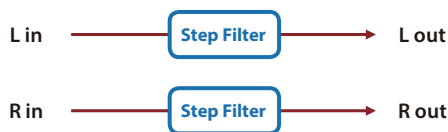

Parameter	Value	Explanation
Step 1–16	0–127	Cutoff frequency at each step
Rate Sync (Rate (sync switch))	OFF, ON	If this is ON, the rate synchronizes with the tempo of the rhythm. ➔ "Tempo" (p. 16)
Rate (Rate (Hz))	0.05–10.00 [Hz]	Frequency of modulation
Rate Note (Rate (note))	Note ➔ "Note" (p. 64)	
Attack	0–127	Speed at which the cutoff frequency changes between steps
Type (Filter Type)	LPF, BPF, HPF, NOTCH	Type of filter Frequency range that will pass through each filter LPF: Frequencies below the cutoff BPF: Frequencies in the region of the cutoff HPF: Frequencies above the cutoff NOTCH: Frequencies other than the region of the cutoff
Slope (Filter Slope)	-12, -24, -36 [dB]	Amount of attenuation per octave -12 dB: Gentle, -24 dB: Steep, -36 dB: Extremely steep
Reso (Filter Resonance)	0–127	Filter resonance level Increasing this value will emphasize the region near the cutoff frequency.
Gain (Filter Gain)	0–+12 [dB]	Amount of boost for the filter output
Level	0–127	Output Level

Enhancer

Controls the overtone structure of the high frequencies, adding sparkle and tightness to the sound.

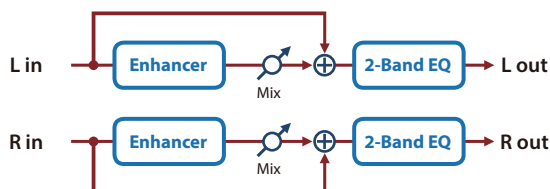

Parameter	Value	Explanation
Sens	0–127	Sensitivity of the enhancer
Mix	0–127	Level of the overtones generated by the enhancer
Low Gain	-15–+15 [dB]	Amount of boost/cut for the low-frequency range
High Gain	-15–+15 [dB]	Amount of boost/cut for the high-frequency range
Level	0–127	Output Level

Auto Wah

Cyclically controls a filter to create cyclic change in timbre.



0

Parameter	Value	Explanation
Mode (Filter Type)	LPF, BPF	Type of filter LPF: The wah effect will be applied over a wide frequency range. BPF: The wah effect will be applied over a narrow frequency range.
Manual	0–127	Center frequency at which the wah effect is applied
Peak	0–127	Width of the frequency region at which the wah effect is applied Increasing this value will make the frequency region narrower.
Sens	0–127	Sensitivity with which the filter is modified
Polarity	UP, DOWN	Direction in which the filter will move UP: The filter will change toward a higher frequency. DOWN: The filter will change toward a lower frequency.
Rate Sync (Rate (sync switch))	OFF, ON	If this is ON, the rate synchronizes with the tempo of the rhythm. ➔ "Tempo" (p. 16)
Rate (Rate (Hz))	0.05–10.00 [Hz]	Frequency of modulation
Rate Note (Rate (note))	Note ➔ "Note" (p. 64)	
Depth	0–127	Depth at which the wah effect is modulated
Phase	0–180 [deg]	Adjusts the degree of phase shift of the left and right sounds when the wah effect is applied.
Low Gain	-15–+15 [dB]	Amount of boost/cut for the low-frequency range
High Gain	-15–+15 [dB]	Amount of boost/cut for the high-frequency range
Level	0–127	Output Level

Humanizer

Adds a vowel character to the sound, making it similar to a human voice.

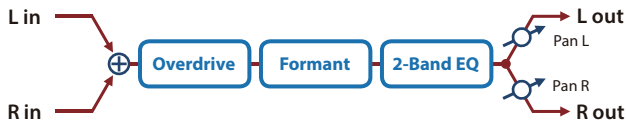

Parameter	Value	Explanation
Drive Sw (Drive Switch)	OFF, ON	Overdrive on/off
Drive	0–127	Degree of distortion Also changes the volume.
Vowel1	a, e, i, o, u	Selects the vowel.
Vowel2	a, e, i, o, u	
Rate Sync (Rate (sync switch))	OFF, ON	If this is ON, the rate synchronizes with the tempo of the rhythm. ➔ “Tempo” (p. 16)
Rate (Rate (Hz))	0.05–10.00 [Hz]	Frequency at which the two vowels switch
Rate Note (Rate (note))	Note ➔ “Note” (p. 64)	
Depth	0–127	Effect depth
In Sync Sw (Input Sync Switch)	OFF, ON	LFO reset on/off Determines whether the LFO for switching the vowels is reset by the input signal (ON) or not (OFF).
InSyncThres (Input Sync Threshold)	0–127	Volume level at which reset is applied
Manual	0–100	Point at which Vowel 1/2 switch 0–49: Vowel 1 will have a longer duration. 50: Vowel 1 and 2 will be of equal duration. 51–100: Vowel 2 will have a longer duration.
Low Gain	-15–+15 [dB]	Amount of boost/cut for the low-frequency range
High Gain	-15–+15 [dB]	Amount of boost/cut for the high-frequency range
Pan	L64–63R	Stereo location of the output sound
Level	0–127	Output Level

Speaker Sim (Speaker Simulator)

Simulates the speaker type and mic settings used to record the speaker sound.



Parameter	Value	Explanation		
		Cabinet	Diameter (in inches) and number of the speaker	Microphone
Type (Speaker Type)	SMALL 1	small open-back enclosure	10	dynamic
	SMALL 2	small open-back enclosure	10	dynamic
	MIDDLE	open back enclosure	12 x 1	dynamic
	JC-120	open back enclosure	12 x 2	dynamic
	BUILT-IN 1	open back enclosure	12 x 2	dynamic
	BUILT-IN 2	open back enclosure	12 x 2	condenser
	BUILT-IN 3	open back enclosure	12 x 2	condenser
	BUILT-IN 4	open back enclosure	12 x 2	condenser
	BUILT-IN 5	open back enclosure	12 x 2	condenser
	BG STACK 1	sealed enclosure	12 x 2	condenser
	BG STACK 2	large sealed enclosure	12 x 2	condenser
	MS STACK 1	large sealed enclosure	12 x 4	condenser
	MS STACK 2	large sealed enclosure	12 x 4	condenser
	METAL STACK	large double stack	12 x 4	condenser
2-STACK	large double stack	12 x 4	condenser	
3-STACK	large triple stack	12 x 4	condenser	
Mic Setting	1, 2, 3	Adjusts the location of the mic that is recording the sound of the speaker. This can be adjusted in three steps, with the mic becoming more distant in the order of 1, 2, and 3.		
Mic Level	0–127	Volume of the microphone		
Direct Lv	0–127	Volume of the direct sound		
Level	0–127	Output Level		

Phaser

A phase-shifted sound is added to the original sound and modulated.

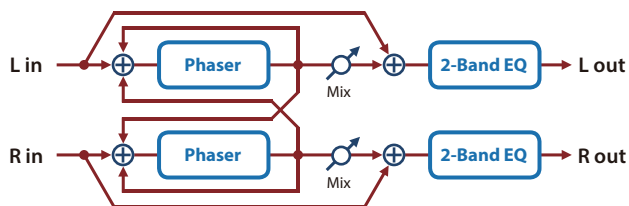

Parameter	Value	Explanation
Mode	4-STAGE, 8-STAGE, 12-STAGE	Number of stages in the phaser
Manual	0–127	Adjusts the basic frequency from which the sound will be modulated.
Rate Sync (Rate (sync switch))	OFF, ON	If this is ON, the rate synchronizes with the tempo of the rhythm. ➔ "Tempo" (p. 16)
Rate (Rate (Hz))	0.05–10.00 [Hz]	Frequency of modulation
Rate Note (Rate (note))	Note ➔ "Note" (p. 64)	
Depth	0–127	Depth of modulation
Polarity	INVERSE, SYNCHRO	Selects whether the left and right phase of the modulation will be the same or the opposite. INVERSE: The left and right phase will be opposite. When using a mono source, this spreads the sound. SYNCHRO: The left and right phase will be the same. Select this when inputting a stereo source.
Resonance	0–127	Amount of feedback
Feedback (Cross Feedback)	-98–+98 [%]	Adjusts the proportion of the phaser sound that is fed back into the effect. Negative (-) settings will invert the phase.
Mix	0–127	Level of the phase-shifted sound
Low Gain	-15–+15 [dB]	Amount of boost/cut for the low-frequency range
High Gain	-15–+15 [dB]	Amount of boost/cut for the high-frequency range
Level	0–127	Output Level

Small Phaser

This simulates an analog phaser of the past.

It is particularly suitable for electric piano.

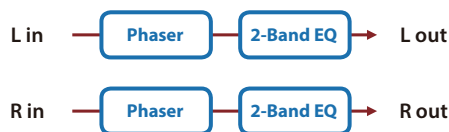

Parameter	Value	Explanation
Rate	0–100	Frequency of modulation
Color	1, 2	Modulation character
Low Gain	-15–+15 [dB]	Amount of boost/cut for the low-frequency range
High Gain	-15–+15 [dB]	Amount of boost/cut for the high-frequency range
Level	0–127	Output Level

Script 90

This simulates a different analog phaser than Small Phaser.

It is particularly suitable for electric piano.

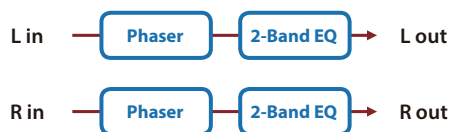

Parameter	Value	Explanation
Speed	0–100	Speed of modulation
Depth	0–127	Depth of modulation
Low Gain	-15–+15 [dB]	Amount of boost/cut for the low-frequency range
High Gain	-15–+15 [dB]	Amount of boost/cut for the high-frequency range
Level	0–127	Output Level

Step Phaser

The phaser effect will be varied gradually.

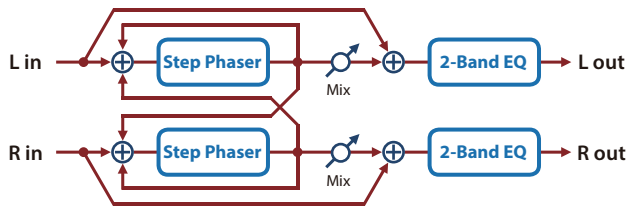

Parameter	Value	Explanation
Mode	4-STAGE, 8-STAGE, 12-STAGE	Number of stages in the phaser
Manual	0–127	Adjusts the basic frequency from which the sound will be modulated.
Rate Sync (Rate (sync switch))	OFF, ON	If this is ON, the rate synchronizes with the tempo of the rhythm. ➔ "Tempo" (p. 16)
Rate Hz (Rate (Hz))	0.05–10.00 [Hz]	Frequency of modulation
Rate Note (Rate (note))	Note ➔ "Note" (p. 64)	
Depth	0–127	Depth of modulation
Polarity	INVERSE, SYNCHRO	Selects whether the left and right phase of the modulation will be the same or the opposite. INVERSE: The left and right phase will be opposite. When using a mono source, this spreads the sound. SYNCHRO: The left and right phase will be the same. Select this when inputting a stereo source.
Resonance	0–127	Amount of feedback
Feedback (Cross Feedback)	-98–+98 [%]	Adjusts the proportion of the phaser sound that is fed back into the effect. Negative (-) settings will invert the phase.
S Rate Sync (Step Rate (sync switch))	OFF, ON	If this is ON, the rate synchronizes with the tempo of the rhythm. ➔ "Tempo" (p. 16)
S. Rate (Step Rate (Hz))	0.10–20.00 [Hz]	Rate of the step-wise change in the phaser effect
S. Rate Nt (Step Rate (note))	Note ➔ "Note" (p. 64)	
Mix	0–127	Level of the phase-shifted sound
Low Gain	-15–+15 [dB]	Amount of boost/cut for the low-frequency range
High Gain	-15–+15 [dB]	Amount of boost/cut for the high-frequency range
Level	0–127	Output Level

M StagePhsr (Multi Stage Phaser)

Extremely high settings of the phase difference produce a deep phaser effect.

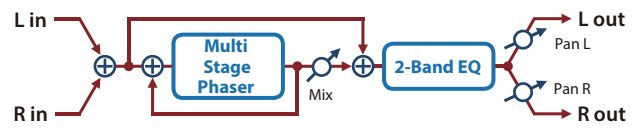

Parameter	Value	Explanation
Mode	4-STAGE, 8-STAGE, 12-STAGE, 16-STAGE, 20-STAGE, 24-STAGE	Number of stages in the phaser
Manual	0–127	Adjusts the basic frequency from which the sound will be modulated.
Rate Sync (Rate (sync switch))	OFF, ON	If this is ON, the rate synchronizes with the tempo of the rhythm. ➔ "Tempo" (p. 16)
Rate (Rate (Hz))	0.05–10.00 [Hz]	Frequency of modulation
Rate Note (Rate (note))	Note ➔ "Note" (p. 64)	
Depth	0–127	Depth of modulation
Resonance	0–127	Amount of feedback
Mix	0–127	Level of the phase-shifted sound
Pan	L64–63R	Stereo location of the output sound
Low Gain	-15–+15 [dB]	Amount of boost/cut for the low-frequency range
High Gain	-15–+15 [dB]	Amount of boost/cut for the high-frequency range
Level	0–127	Output Level

Inf Phaser (Infinite Phaser)

A phaser that continues raising/lowering the frequency at which the sound is modulated.

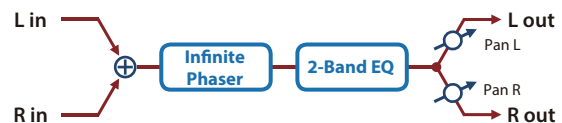

Parameter	Value	Explanation
Mode	1, 2, 3, 4	Higher values will produce a deeper phaser effect.
Speed	-100–+100	Speed at which to raise or lower the frequency at which the sound is modulated (+: upward / -: downward)
Resonance	0–127	Amount of feedback
Mix	0–127	Level of the phase-shifted sound
Pan	L64–63R	Stereo location of the output sound
Low Gain	-15–+15 [dB]	Amount of boost/cut for the low-frequency range
High Gain	-15–+15 [dB]	Amount of boost/cut for the high-frequency range
Level	0–127	Output Level

Ring Mod (Ring Modulator)

This is an effect that applies amplitude modulation (AM) to the input signal, producing bell-like sounds. You can also change the modulation frequency in response to changes in the volume of the sound sent into the effect.



Parameter	Value	Explanation
Frequency	0–127	Adjusts the frequency at which modulation is applied.
Sens	0–127	Adjusts the amount of frequency modulation applied.
Polarity	UP, DOWN	Determines whether the frequency modulation moves towards higher frequencies or lower frequencies. UP: The filter will change toward a higher frequency. DOWN: The filter will change toward a lower frequency.
Low Gain	-15–+15 [dB]	Amount of boost/cut for the low-frequency range
High Gain	-15–+15 [dB]	Amount of boost/cut for the high-frequency range
Balance	D100: 0W–D0: 100W	Volume balance between the direct sound (D) and the effect sound (W)
Level	0–127	Output Level

Tremolo

Cyclically changes the volume.



Parameter	Value	Explanation
Mod Wave (Modulation Wave)	TRI, SQR, SIN, SAW1, SAW2, TRP	Modulation Wave TRI : Triangle wave SQR : Square wave SIN : Sine wave SAW1/2 : Sawtooth wave TRP : Trapezoidal wave
Rate Sync (Rate (sync switch))	OFF, ON	If this is ON, the rate synchronizes with the tempo of the rhythm. ➔ "Tempo" (p. 16)
Rate (Rate (Hz))	0.05–10.00 [Hz]	Frequency of the change
Rate Note (Rate (note))	Note ➔ "Note" (p. 64)	
Depth	0–127	Depth to which the effect is applied
Low Gain	-15–+15 [dB]	Amount of boost/cut for the low-frequency range
High Gain	-15–+15 [dB]	Amount of boost/cut for the high-frequency range
Level	0–127	Output Level

Auto Pan

Cyclically modulates the stereo location of the sound.



Parameter	Value	Explanation
Mod Wave (Modulation Wave)	TRI, SQR, SIN, SAW1, SAW2, TRP	Modulation Wave TRI : Triangle wave SQR : Square wave SIN : Sine wave SAW1/2 : Sawtooth wave TRP : Trapezoidal wave
Rate Sync (Rate (sync switch))	OFF, ON	If this is ON, the rate synchronizes with the tempo of the rhythm. ➔ "Tempo" (p. 16)
Rate (Rate (Hz))	0.05–10.00 [Hz]	Frequency of the change
Rate Note (Rate (note))	Note ➔ "Note" (p. 64)	
Depth	0–127	Depth to which the effect is applied
Low Gain	-15–+15 [dB]	Amount of boost/cut for the low-frequency range
High Gain	-15–+15 [dB]	Amount of boost/cut for the high-frequency range
Level	0–127	Output Level

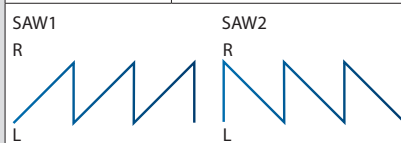

Slicer

By applying successive cuts to the sound, this effect turns a conventional sound into a sound that appears to be played as a backing phrase. This is especially effective when applied to sustain-type sounds.



Parameter	Value	Explanation
Step 1–16	0–127	Level at each step
Rate Sync (Rate (sync switch))	OFF, ON	If this is ON, the rate synchronizes with the tempo of the rhythm. → "Tempo" (p. 16)
Rate (Rate (Hz))	0.05–10.00 [Hz]	Rate at which the 16-step sequence will cycle
Rate Note (Rate (note))	Note → "Note" (p. 64)	
Attack	0–127	Speed at which the level changes between steps
In Sync Sw (Input Sync Sw)	OFF, ON	Specifies whether an input note will cause the sequence to resume from the first step of the sequence (ON) or not (OFF)
lInSyncThres (Input Sync Threshold)	0–127	Volume at which an input note will be detected
Mode	LEGATO, SLASH	Sets the manner in which the volume changes as one step progresses to the next. LEGATO: The change in volume from one step's level to the next remains unaltered. If the level of a following step is the same as the one preceding it, there is no change in volume. SLASH: The level is momentarily set to 0 before progressing to the level of the next step. This change in volume occurs even if the level of the following step is the same as the preceding step.
Shuffle	0–127	Timing of volume changes in levels for even numbered steps (step 2, step 4, step 6...). The higher the value, the later the beat progresses.
Level	0–127	Output Level

Rotary

This simulates a classic rotary speaker of the past.

Since the operation of the high-frequency and low-frequency rotors can be specified independently, the distinctive modulation can be reproduced realistically. This is most effective on organ patches.

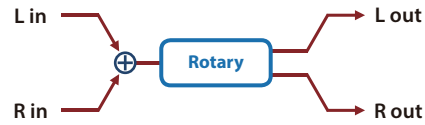

Parameter	Value	Explanation
Speed	SLOW, FAST	Simultaneously switch the rotational speed of the low frequency rotor and high frequency rotor. SLOW: Slows down the rotation to the Slow Rate. FAST: Speeds up the rotation to the Fast Rate.
Wf Slow (Woofer Slow Speed)	0.05–10.00 [Hz]	Slow speed (SLOW) of the low frequency rotor
Wf Fast (Woofer Fast Speed)	0.05–10.00 [Hz]	Fast speed (FAST) of the low frequency rotor
Wf Accel (Woofer Acceleration)	0–15	Adjusts the time it takes the low frequency rotor to reach the newly selected speed when switching from fast to slow (or slow to fast) speed. Lower values will require longer times.
Wf Level (Woofer Level)	0–127	Volume of the low frequency rotor
Tw Slow (Tweeter Slow Speed)	0.05–10.00 [Hz]	Settings of the high frequency rotor The parameters are the same as for the low frequency rotor
Tw Fast (Tweeter Fast Speed)	0.05–10.00 [Hz]	
Tw Accel (Tweeter Acceleration)	0–15	
Tw Level (Tweeter Level)	0–127	
Separation	0–127	Spatial dispersion of the sound
Level	0–127	Output Level

VK Rotary

This type provides modified response for the rotary speaker, with the low end boosted further.

This effect features the same specifications as the VK-7's built-in rotary speaker.

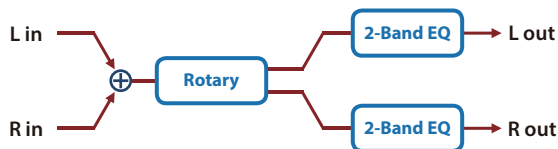

Parameter	Value	Explanation
Speed	SLOW, FAST	Rotational speed of the rotating speaker SLOW: Slow FAST: Fast
Brake	OFF, ON	Switches the rotation of the rotary speaker. When this is turned on, the rotation will gradually stop. When it is turned off, the rotation will gradually resume.
Wf Slow (Woofer Slow Speed)	0.05–10.00 [Hz]	Low-speed rotation speed of the woofer
Wf Fast (Woofer Fast Speed)	0.05–10.00 [Hz]	High-speed rotation speed of the woofer
Wf Trs Up (Woofer Trans Up)	0–127	Adjusts the rate at which the woofer rotation speeds up when the rotation is switched from Slow to Fast.
Wf Trs Dw (Woofer Trans Down)	0–127	Adjusts the rate at which the woofer rotation speeds up when the rotation is switched from Fast to Slow.
Wf Level (Woofer Level)	0–127	Volume of the woofer
Tw Slow (Tweeter Slow Speed)	0.05–10.00 [Hz]	Settings of the tweeter The parameters are the same as for the woofer.
Tw Fast (Tweeter Fast Speed)	0.05–10.00 [Hz]	
Tw Trs Up (Tweeter Trans Up)	0–127	
Tw Trs Dw (Tweeter Trans Down)	0–127	
Tw Level (Tweeter Level)	0–127	
Spread	0–10	Sets the rotary speaker stereo image. ?The higher the value set, the wider the sound is spread out.
Low Gain	-15–+15 [dB]	Amount of boost/cut for the low-frequency range
High Gain	-15–+15 [dB]	Amount of boost/cut for the high-frequency range
Level	0–127	Output Level
OD Switch (Overdrive Switch)	OFF, ON	Overdrive on/off
OD Gain (Overdrive Gain)	0–127	Overdrive input level Higher values will increase the distortion.
OD Drive (Overdrive Drive)	0–127	Degree of distortion

Parameter	Value	Explanation
OD Level (Overdrive Level)	0–127	Volume of the overdrive

Chorus

This is a stereo chorus. A filter is provided so that you can adjust the timbre of the chorus sound.

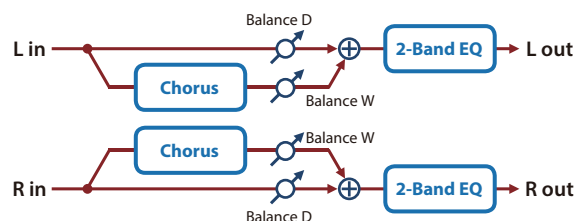

Parameter	Value	Explanation
Type	OFF, LPF, HPF	Type of filter OFF: No filter is used LPF: Cuts the frequency range above the Cutoff Freq HPF: Cuts the frequency range below the Cutoff Freq
Cutoff (Cutoff Freq)	200, 250, 315, 400, 500, 630, 800, 1000, 1250, 1600, 2000, 2500, 3150, 4000, 5000, 6300, 8000 [Hz]	Basic frequency of the filter
Pre Delay	0.0–100 [msec]	Adjusts the delay time from the direct sound until the chorus sound is heard.
Rate Sync (Rate (sync switch))	OFF, ON	If this is ON, the rate synchronizes with the tempo of the rhythm. ➔ "Tempo" (p. 16)
Rate (Rate (Hz))	0.05–10.00 [Hz]	Frequency of modulation
Rate Note (Rate (note))	Note ➔ "Note" (p. 64)	
Depth	0–127	Depth of modulation
Phase	0–180 [deg]	Spatial spread of the sound
Low Gain	-15–+15 [dB]	Amount of boost/cut for the low-frequency range
High Gain	-15–+15 [dB]	Amount of boost/cut for the high-frequency range
Balance	D100: 0W–D0: 100W	Volume balance between the direct sound (D) and the chorus sound (W)
Level	0–127	Output Level

Flanger

This is a stereo flanger (The LFO has the same phase for left and right). Produces a metallic resonance reminiscent of a jet airplane taking off and landing. A filter is provided so that you can adjust the timbre of the flanged sound.

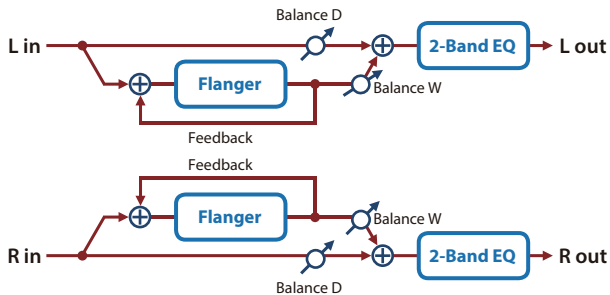

Parameter	Value	Explanation
Type	OFF, LPF, HPF	Type of filter OFF: No filter is used LPF: Cuts the frequency range above the Cutoff Freq HPF: Cuts the frequency range below the Cutoff Freq
Cutoff (Cutoff Freq)	200, 250, 315, 400, 500, 630, 800, 1000, 1250, 1600, 2000, 2500, 3150, 4000, 5000, 6300, 8000 [Hz]	Basic frequency of the filter
Pre Delay	0.0–100 [msec]	Adjusts the delay time from when the direct sound begins until the flanger sound is heard.
Rate Sync (Rate (sync switch))	OFF, ON	If this is ON, the rate synchronizes with the tempo of the rhythm. ➔ "Tempo" (p. 16)
Rate (Rate (Hz))	0.05–10.00 [Hz]	Frequency of modulation
Rate Note (Rate (note))	Note ➔ "Note" (p. 64)	
Depth	0–127	Depth of modulation
Phase	0–180 [deg]	Spatial spread of the sound
Feedback	-98–+98 [%]	Adjusts the proportion of the flanger sound that is fed back into the effect. Negative (-) settings will invert the phase.
Low Gain	-15–+15 [dB]	Amount of boost/cut for the low-frequency range
High Gain	-15–+15 [dB]	Amount of boost/cut for the high-frequency range
Balance	D100: 0W–D0: 100W	Volume balance between the direct sound (D) and the flanger sound (W)
Level	0–127	Output Level

StepFlanger

This is a flanger in which the flanger pitch changes in steps. The speed at which the pitch changes can also be specified in terms of a note-value of a specified tempo.

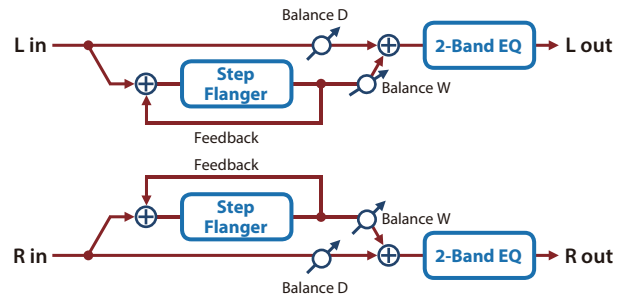

Parameter	Value	Explanation
Type	OFF, LPF, HPF	Type of filter OFF: No filter is used LPF: Cuts the frequency range above the Cutoff Freq HPF: Cuts the frequency range below the Cutoff Freq
Cutoff (Cutoff Freq)	200, 250, 315, 400, 500, 630, 800, 1000, 1250, 1600, 2000, 2500, 3150, 4000, 5000, 6300, 8000 [Hz]	Basic frequency of the filter
Pre Delay	0.0–100.0 [msec]	Adjusts the delay time from when the direct sound begins until the flanger sound is heard.
Rate Sync (Rate (sync switch))	OFF, ON	If this is ON, the rate synchronizes with the tempo of the rhythm. ➔ "Tempo" (p. 16)
Rate (Rate (Hz))	0.05–10.00 [Hz]	Frequency of modulation
Rate Note (Rate (note))	Note ➔ "Note" (p. 64)	
Depth	0–127	Depth of modulation
Phase	0–180 [deg]	Spatial spread of the sound
Feedback	-98–+98 [%]	Adjusts the proportion of the flanger sound that is fed back into the effect. Negative (-) settings will invert the phase.
S. Rate Sync (Step Rate (sync switch))	OFF, ON	If this is ON, the rate synchronizes with the tempo of the rhythm. ➔ "Tempo" (p. 16)
S. Rate (Step Rate (Hz))	0.10–20.00 [Hz]	Rate (period) of pitch change
S. Rate Nt (Step Rate (note))	Note ➔ "Note" (p. 64)	
Low Gain	-15–+15 [dB]	Amount of boost/cut for the low-frequency range
High Gain	-15–+15 [dB]	Amount of boost/cut for the high-frequency range
Balance	D100: 0W–D0: 100W	Volume balance between the direct sound (D) and the flanger sound (W)
Level	0–127	Output Level

Hexa-Chorus

Uses a six-phase chorus (six layers of chorused sound) to give richness and spatial spread to the sound.

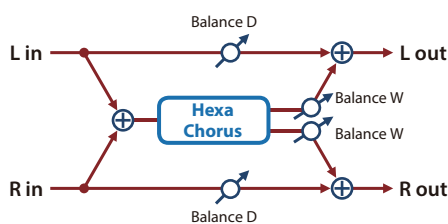

Parameter	Value	Explanation
Pre Delay	0.0–100 [msec]	Adjusts the delay time from the direct sound until the chorus sound is heard.
Rate Sync (Rate (sync switch))	OFF, ON	If this is ON, the rate synchronizes with the tempo of the rhythm. ⇒ "Tempo" (p. 16)
Rate (Rate (Hz))	0.05–10.00 [Hz]	Frequency of modulation
Rate Note (Rate (note))	Note ⇒ "Note" (p. 64)	
Depth	0–127	Depth of modulation
PreDly Dev (Pre Delay Deviation)	0–20	Adjusts the differences in Pre Delay between each chorus sound.
Depth Dev (Depth Deviation)	-20–+20	Adjusts the difference in modulation depth between each chorus sound.
Pan Dev (Pan Deviation)	0–20	Adjusts the difference in stereo location between each chorus sound. 0: All chorus sounds will be in the center. 20: Each chorus sound will be spaced at 60 degree intervals relative to the center.
Balance	D100: 0W–D0: 100W	Volume balance between the direct sound (D) and the chorus sound (W)
Level	0–127	Output Level

Trem Chorus (Tremolo Chorus)

This is a chorus effect with added Tremolo (cyclic modulation of volume).

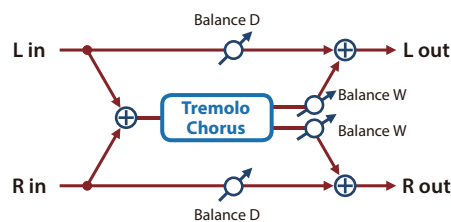

Parameter	Value	Explanation
Pre Delay	0.0–100 [msec]	Adjusts the delay time from the direct sound until the chorus sound is heard.
Cho Sync (Chorus Rate (sync switch))	OFF, ON	If this is ON, the rate synchronizes with the tempo of the rhythm. ⇒ "Tempo" (p. 16)
C. Rate (Chorus Rate (Hz))	0.05–10.00 [Hz]	Modulation frequency of the chorus effect
C. Rate Nt (Chorus Rate (note))	Note ⇒ "Note" (p. 64)	
Cho Depth (Chorus Depth)	0–127	Modulation depth of the chorus effect
Trm Sync (Tremolo Rate (sync switch))	OFF, ON	If this is ON, the rate synchronizes with the tempo of the rhythm. ⇒ "Tempo" (p. 16)
T. Rate (Tremolo Rate (Hz))	0.05–10.00 [Hz]	Modulation frequency of the tremolo effect
T. Rate Nt (Tremolo Rate (note))	Note ⇒ "Note" (p. 64)	
Trm Separate (Tremolo Separation)	0–127	Spread of the tremolo effect
Trm Phase (Tremolo Phase)	0–180 [deg]	Spread of the tremolo effect
Balance	D100: 0W–D0: 100W	Volume balance between the direct sound (D) and the chorus sound (W)
Level	0–127	Output Level

Space-D

This is a multiple chorus that applies two-phase modulation in stereo. It gives no impression of modulation, but produces a transparent chorus effect.

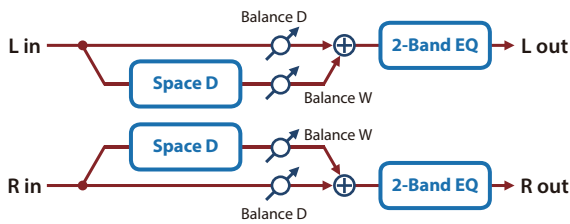

Parameter	Value	Explanation
Pre Delay	0.0–100 [msec]	Adjusts the delay time from the direct sound until the chorus sound is heard.
Rate Sync (Rate (sync switch))	OFF, ON	If this is ON, the rate synchronizes with the tempo of the rhythm. ➔ "Tempo" (p. 16)
Rate (Rate (Hz))	0.05–10.00 [Hz]	Frequency of modulation
Rate Note (Rate (note))	Note ➔ "Note" (p. 64)	
Depth	0–127	Depth of modulation
Phase	0–180 [deg]	Spatial spread of the sound
Low Gain	-15–+15 [dB]	Amount of boost/cut for the low-frequency range
High Gain	-15–+15 [dB]	Amount of boost/cut for the high-frequency range
Balance	D100: 0W–D0: 100W	Volume balance between the direct sound (D) and the chorus sound (W)
Level	0–127	Output Level

Overdrive

This is an overdrive that provides heavy distortion.

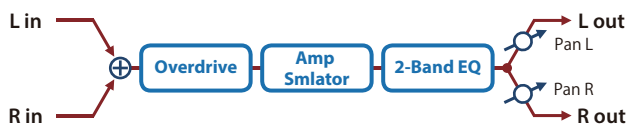

Parameter	Value	Explanation
Drive	0–127	Degree of distortion Also changes the volume.
Tone	0–127	Sound quality of the Overdrive effect
Amp Switch	OFF, ON	Turns the Amp Simulator on/off.
Amp Type (Amp Type)	SMALL, BUILT-IN, 2-STACK, 3-STACK	Type of guitar amp SMALL: Small amp BUILT-IN: Single-unit type amp 2-STACK: Large double stack amp 3-STACK: Large triple stack amp
Low Gain	-15–+15 [dB]	Amount of boost/cut for the low-frequency range
High Gain	-15–+15 [dB]	Amount of boost/cut for the high-frequency range
Pan	L64–63R	Stereo location of the output sound
Level	0–127	Output Level

Distortion

Produces a more intense distortion than Overdrive.



Parameter	Value	Explanation
Drive	0–127	Degree of distortion Also changes the volume.
Tone	0–127	Sound quality of the Overdrive effect
Amp Switch	OFF, ON	Turns the Amp Simulator on/off.
Amp Type (Amp Type)	SMALL, BUILT-IN, 2-STACK, 3-STACK	Type of guitar amp SMALL: Small amp BUILT-IN: Single-unit type amp 2-STACK: Large double stack amp 3-STACK: Large triple stack amp
Low Gain	-15–+15 [dB]	Amount of boost/cut for the low-frequency range
High Gain	-15–+15 [dB]	Amount of boost/cut for the high-frequency range
Pan	L64–63R	Stereo location of the output sound
Level	0–127	Output Level

T-Scream

This models a classic analog overdrive. It is distinctive in adding an appropriate amount of overtones without muddying the sound.

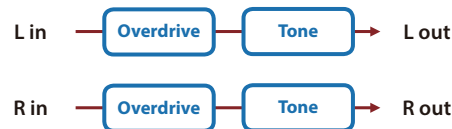

Parameter	Value	Explanation
Distortion	0–127	Degree of distortion Also changes the volume.
Tone	0–127	Tonal character of the overdrive
Level	0–127	Output Level

Gt Amp Sim (Guitar Amp Simulator)

This is an effect that simulates the sound of a guitar amplifier.

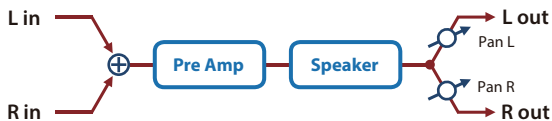

Parameter	Value	Explanation
Pre Amp Sw (Pre Amp Switch)	OFF, ON	Turns the amp switch on/off.
AmpType (Pre Amp Type)	Type of guitar amp	
	JC-120	This models the sound of the Roland JC-120.
	CLEAN TWIN	This models a Fender Twin Reverb.
	MATCH DRIVE	This models the sound input to left input on a Matchless D/C-30. A simulation of the latest tube amp widely used in styles from blues and rock.
	BG LEAD	This models the lead sound of the MESA/ Boogie combo amp. The sound of a tube amp typical of the late '70s to '80s.
	MS1959I	This models the sound input to Input I on a Marshall 1959. This is a trebly sound suited to hard rock.
	MS1959II	This models the sound input to Input II on a Marshall 1959.
	MS1959I+II	The sound of connecting inputs I and II of the guitar amp in parallel, creating a sound with a stronger low end than I.
	SLDN LEAD	This models a Soldano SLO-100. This is the typical sound of the eighties.
	METAL 5150	This models the lead channel of a Peavey EVH 5150.
	METAL LEAD	This is distortion sound that is ideal for performances of heavy riffs.
	OD-1	This models the sound of the BOSS OD-1. This produces sweet, mild distortion.
	OD-2 TURBO	This is the high-gain overdrive sound of the BOSS OD-2.
	DISTORTION	This gives a basic, traditional distortion sound.
	FUZZ	A fuzz sound with rich harmonic content.
Drive (Pre Amp Drive)	0-127	Volume and amount of distortion of the amp
Master Lv (Pre Amp Master)	0-127	Volume of the entire pre-amp
Gain (Pre Amp Gain)	LOW, MIDDLE, HIGH	Amount of pre-amp distortion
Bass (Pre Amp Bass)	0-127	Tone of the bass/mid/treble frequency range Middle cannot be set if "MATCH DRIVE" is selected as the Pre Amp Type.
Middle (Pre Amp Middle)		
Treble (Pre Amp Treble)		
Presence (Pre Amp Presence)	0-127	Tone for the ultra-high frequency range

Parameter	Value	Explanation		
Bright (Pre Amp Bright)	OFF, ON	Turning this "On" produces a sharper and brighter sound. * This parameter applies to the "JC-120," "CLEAN TWIN," and "BG LEAD" Pre Amp Types.		
Speaker Sw (Speaker Switch)	OFF, ON	Selects whether the sound will be sent through the speaker simulation (ON) or not (OFF)		
SpType (Speaker Type)		Cabinet	Diameter (inches) and number of the speaker	Microphone
	SMALL 1	small open-back enclosure	10	dynamic
	SMALL 2	small open-back enclosure	10	dynamic
	MIDDLE	open back enclosure	12 x 1	dynamic
	JC-120	open back enclosure	12 x 2	dynamic
	BUILT-IN 1	open back enclosure	12 x 2	dynamic
	BUILT-IN 2	open back enclosure	12 x 2	condenser
	BUILT-IN 3	open back enclosure	12 x 2	condenser
	BUILT-IN 4	open back enclosure	12 x 2	condenser
	BUILT-IN 5	open back enclosure	12 x 2	condenser
	BG STACK1	sealed enclosure	12 x 2	condenser
	BG STACK2	large sealed enclosure	12 x 2	condenser
	MS STACK1	large sealed enclosure	12 x 4	condenser
	MS STACK2	large sealed enclosure	12 x 4	condenser
	MTL STACK	large double stack	12 x 4	condenser
2-STACK	large double stack	12 x 4	condenser	
3-STACK	large triple stack	12 x 4	condenser	
Mic Setting	1, 2, 3	Adjusts the location of the mic that is recording the sound of the speaker. This can be adjusted in three steps, with the mic becoming more distant in the order of 1, 2, and 3.		
Mic Level	0-127	Volume of the microphone		
Direct Level	0-127	Volume of the direct sound		
Pan	L64-63R	Stereo location of the output sound		
Level	0-127	Output Level		

Compressor

Flattens out high levels and boosts low levels, smoothing out fluctuations in volume.

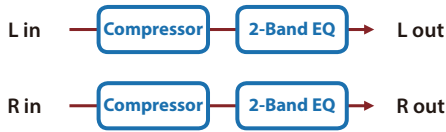

Parameter	Value	Explanation
Attack	0–124	Sets the speed at which compression starts
Release	0–124	Adjusts the time after the signal volume falls below the Threshold Level until compression is no longer applied.
Threshold	-60–0 [dB]	Adjusts the volume at which compression begins
Knee	0–30 [dB]	This is a function that smooths the onset of compression from the uncompressed state; it gradually applies compression starting earlier than Threshold. Higher values produce a smoother transition.
Ratio	1: 1, 1.5: 1, 2: 1, 4: 1, 16: 1, INF: 1	Compression ratio
Post Gain	0–+18 [dB]	Adjusts the output gain.
Level	0–127	Output Level

Limiter

Compresses signals that exceed a specified volume level, preventing distortion from occurring.

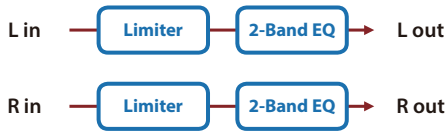

Parameter	Value	Explanation
Release	0–127	Adjusts the time after the signal volume falls below the Threshold Level until compression is no longer applied.
Threshold	0–127	Adjusts the volume at which compression begins
Ratio	1.5: 1, 2: 1, 4: 1, 100: 1	Compression ratio
Post Gain	0–+18 [dB]	Adjusts the output gain.
Low Gain	-15–+15 [dB]	Amount of boost/cut for the low-frequency range
High Gain	-15–+15 [dB]	Amount of boost/cut for the high-frequency range
Level	0–127	Output Level

Sustainer

By compressing loud input and boosting low input, this effect keeps the volume consistent to produce a sustain effect without distortion.

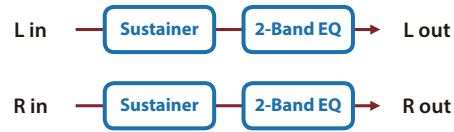

Parameter	Value	Explanation
Sustain	0–127	Adjusts the range in which a low input signal is boosted to a consistent volume. Higher values produce longer sustain.
Attack	0–127	Time until the volume is compressed
Release	0–127	Time until compression is removed
Post Gain	-15–+15 [dB]	Adjusts the output gain.
Low Gain	-15–+15 [dB]	Amount of boost/cut for the low-frequency range
High Gain	-15–+15 [dB]	Amount of boost/cut for the high-frequency range
Level	0–127	Output Level

Gate

Cuts the reverb's delay according to the volume of the sound sent into the effect. Use this when you want to create an artificial-sounding decrease in the reverb's decay.

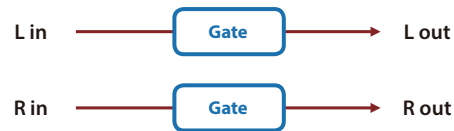

Parameter	Value	Explanation
Threshold	0–127	Volume level at which the gate begins to close
Mode	GATE, DUCK	Type of gate GATE: The gate will close when the volume of the original sound decreases, cutting the original sound. DUCK (Ducking): The gate will close when the volume of the original sound increases, cutting the original sound.
Attack	0–127	Adjusts the time it takes for the gate to fully open after being triggered.
Hold	0–127	Adjusts the time it takes for the gate to start closing after the source sound falls beneath the Threshold.
Release	0–127	Adjusts the time it takes the gate to fully close after the hold time.
Balance	D100: 0W–D0: 100W	Volume balance between the direct sound (D) and the effect sound (W)
Level	0–127	Output Level

Delay

This is a stereo delay.

When Feedback Mode is NORMAL:

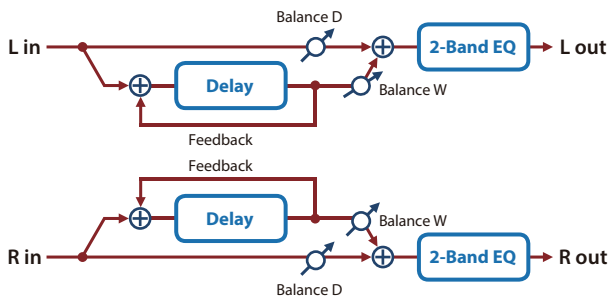

When Feedback Mode is CROSS:

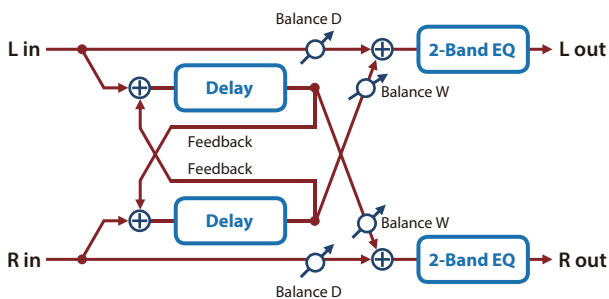

Parameter	Value	Explanation
Dly L Sync (Delay Left sync switch))	OFF, ON	If this is ON, the rate synchronizes with the tempo of the rhythm. ➔ "Tempo" (p. 16)
DL Time (Delay Left (msec))	1-1300	Adjusts the time until the left delay sound is heard.
DLTime Nt (Delay Left (note))	Note ➔ "Note" (p. 64)	
Dly R Sync (Delay Right sync switch))	OFF, ON	If this is ON, the rate synchronizes with the tempo of the rhythm. ➔ "Tempo" (p. 16)
DR Time (Delay Right (msec))	1-1300	Adjusts the time until the right delay sound is heard.
DRTime Nt (Delay Right (note))	Note ➔ "Note" (p. 64)	
Phase L (Phase Left)	NORMAL, INVERSE	NORMAL: Non-inverted INVERT: Inverted
Phase R (Phase Right)		
Fbk Mode (Feedback Mode)	NORMAL, CROSS	Selects the way in which delay sound is fed back into the effect. (See the figures above.)
Feedback	-98+98 [%]	Adjusts the proportion of the delay sound that is fed back into the effect. Negative (-) settings will invert the phase.
HF Damp	200, 250, 315, 400, 500, 630, 800, 1000, 1250, 1600, 2000, 2500, 3150, 4000, 5000, 6300, 8000, BYPASS [Hz]	Adjusts the frequency above which sound fed back to the effect is filtered out. If you don't want to filter out any high frequencies, set this parameter to BYPASS.
Low Gain	-15+15 [dB]	Amount of boost/cut for the low-frequency range
High Gain	-15+15 [dB]	Amount of boost/cut for the high-frequency range

Parameter	Value	Explanation
Balance	D100: 0W-D0: 100W	Volume balance between the direct sound (D) and the delay sound (W)
Level	0-127	Output Level

Mod Delay (Modulation Delay)

Adds modulation to the delayed sound.

When Feedback Mode is NORMAL:

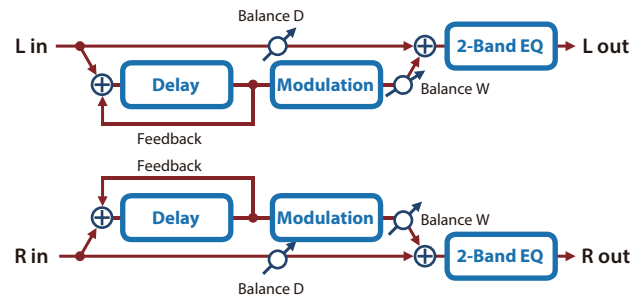

When Feedback Mode is CROSS:

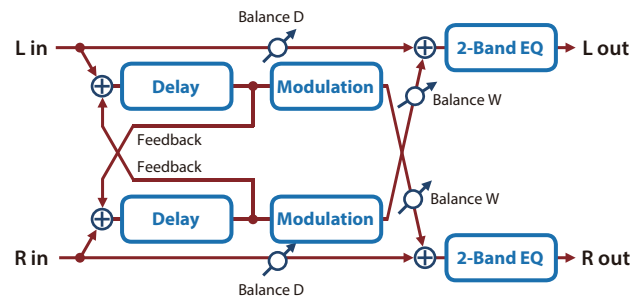

Parameter	Value	Explanation
Dly L Sync (Delay Left sync switch))	OFF, ON	If this is ON, the rate synchronizes with the tempo of the rhythm. ➔ "Tempo" (p. 16)
DL Time (Delay Left (msec))	1-1300	Adjusts the time until the left delay sound is heard.
DLTime Nt (Delay Left (note))	Note ➔ "Note" (p. 64)	
Dly R Sync (Delay Right sync switch))	OFF, ON	If this is ON, the rate synchronizes with the tempo of the rhythm. ➔ "Tempo" (p. 16)
DR Time (Delay Right (msec))	1-1300	Adjusts the time until the right delay sound is heard.
DRTime Nt (Delay Right (note))	Note ➔ "Note" (p. 64)	
Fbk Mode (Feedback Mode)	NORMAL, CROSS	Selects the way in which delay sound is fed back into the effect. (See the figures above.)
Feedback	-98+98 [%]	Adjusts the proportion of the delay sound that is fed back into the effect. Negative (-) settings will invert the phase.
HF Damp	200, 250, 315, 400, 500, 630, 800, 1000, 1250, 1600, 2000, 2500, 3150, 4000, 5000, 6300, 8000, BYPASS [Hz]	Adjusts the frequency above which sound fed back to the effect is filtered out. If you don't want to filter out any high frequencies, set this parameter to BYPASS.

Parameter	Value	Explanation
Rate Sync (Rate (sync switch))	OFF, ON	If this is ON, the rate synchronizes with the tempo of the rhythm. ➔ "Tempo" (p. 16)
Rate (Rate (Hz))	0.05–10.00 [Hz]	Frequency of modulation
Rate Note (Rate (note))	Note ➔ "Note" (p. 64)	
Depth	0–127	Depth of modulation
Phase	0–180 [deg]	Spatial spread of the sound
Low Gain	-15–+15 [dB]	Amount of boost/cut for the low-frequency range
High Gain	-15–+15 [dB]	Amount of boost/cut for the high-frequency range
Balance	D100: 0W–D0: 100W	Volume balance between the direct sound (D) and the delay sound (W)
Level	0–127	Output Level

3Tap PanDly

Produces three delay sounds; center, left and right.

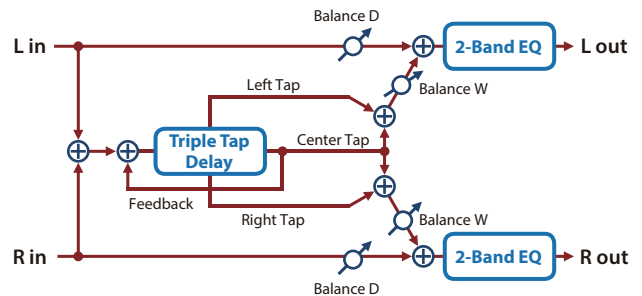

Parameter	Value	Explanation
Dly L Sync (Delay Left (sync switch))	OFF, ON	If this is ON, the rate synchronizes with the tempo of the rhythm. ➔ "Tempo" (p. 16)
DL Time (Delay Left (msec))	1–2600	Adjusts the time until the left delay sound is heard.
DLTime Nt (Delay Left (note))	Note ➔ "Note" (p. 64)	
Dly R Sync (Delay Right (sync switch))	OFF, ON	If this is ON, the rate synchronizes with the tempo of the rhythm. ➔ "Tempo" (p. 16)
DR Time (Delay Right (msec))	1–2600	Adjusts the time until the right delay sound is heard.
DRTime Nt (Delay Right (note))	Note ➔ "Note" (p. 64)	
Dly C Sync (Delay Center (sync switch))	OFF, ON	If this is ON, the rate synchronizes with the tempo of the rhythm. ➔ "Tempo" (p. 16)
DC Time (Delay Center (msec))	1–2600	Adjusts the time until the center delay sound is heard.
DCTime Nt (Delay Center (note))	Note ➔ "Note" (p. 64)	
C Feedback (Center Feedback)	-98–+98 [%]	Adjusts the proportion of the delay sound that is fed back into the effect. Negative (-) settings will invert the phase.
HF Damp	200, 250, 315, 400, 500, 630, 800, 1000, 1250, 1600, 2000, 2500, 3150, 4000, 5000, 6300, 8000, BYPASS [Hz]	Adjusts the frequency above which sound fed back to the effect is filtered out. If you don't want to filter out any high frequencies, set this parameter to BYPASS.
Left Lv	0–127	Volume of each delay sound
Right Lv	0–127	
Center Lv	0–127	
Low Gain	-15–+15 [dB]	Amount of boost/cut for the low-frequency range
High Gain	-15–+15 [dB]	Amount of boost/cut for the high-frequency range
Balance	D100: 0W–D0: 100W	Volume balance between the direct sound (D) and the delay sound (W)
Level	0–127	Output Level

4Tap PanDly

This effect has four delays.

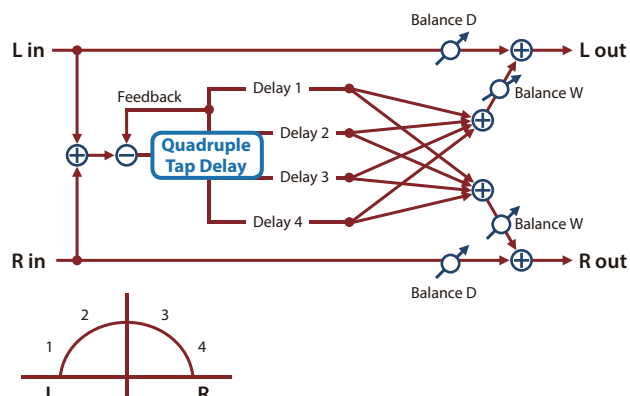

Parameter	Value	Explanation
Low Gain	-15--+15 [dB]	Amount of boost/cut for the low-frequency range
High Gain	-15--+15 [dB]	Amount of boost/cut for the high-frequency range
Balance	D100: 0W-D0: 100W	Volume balance between the direct sound (D) and the delay sound (W)
Level	0-127	Output Level

Parameter	Value	Explanation
Dly1 Sync (Delay 1 Time (sync switch))	OFF, ON	If this is ON, the rate synchronizes with the tempo of the rhythm. ⇒ "Tempo" (p. 16)
D1. Time (Delay 1 Time (msec))	1-2600	Adjusts the time from the original sound until delay 1 sounds is heard.
D1Time Nt (Delay 1 Time (note))	Note ⇒ "Note" (p. 64)	
Dly2 Sync (Delay 2 Time (sync switch))	OFF, ON	If this is ON, the rate synchronizes with the tempo of the rhythm. ⇒ "Tempo" (p. 16)
D2. Time (Delay 2 Time (msec))	1-2600	Adjusts the time from the original sound until delay 2 sounds is heard.
D2Time Nt (Delay 2 Time (note))	Note ⇒ "Note" (p. 64)	
Dly3 Sync (Delay 3 Time (sync switch))	OFF, ON	If this is ON, the rate synchronizes with the tempo of the rhythm. ⇒ "Tempo" (p. 16)
D3. Time (Delay 3 Time (msec))	1-2600	Adjusts the time from the original sound until delay 3 sounds is heard.
D3Time Nt (Delay 3 Time (note))	Note ⇒ "Note" (p. 64)	
Dly4 Sync (Delay 4 Time (sync switch))	OFF, ON	If this is ON, the rate synchronizes with the tempo of the rhythm. ⇒ "Tempo" (p. 16)
D4. Time (Delay 4 Time (msec))	1-2600	Adjusts the time from the original sound until delay 4 sounds is heard.
D4Time Nt (Delay 4 Time (note))	Note ⇒ "Note" (p. 64)	
Dly1 Fbk (Delay 1 Feedback)	-98--+98 [%]	Adjusts the proportion of the delay sound that is fed back into the effect. Negative (-) settings will invert the phase.
HF Damp	200, 250, 315, 400, 500, 630, 800, 1000, 1250, 1600, 2000, 2500, 3150, 4000, 5000, 6300, 8000, BYPASS [Hz]	Adjusts the frequency above which sound fed back to the effect is filtered out. If you don't want to filter out any high frequencies, set this parameter to BYPASS.
Dly1 Lv (Delay 1 Level)	0-127	Volume of each delay
Dly2 Lv (Delay 2 Level)		
Dly3 Lv (Delay 3 Level)		
Dly4 Lv (Delay 4 Level)		

MultiTapDly

This effect provides four delays. Each of the Delay Time parameters can be set to a note length based on the selected tempo. You can also set the panning and level of each delay sound.

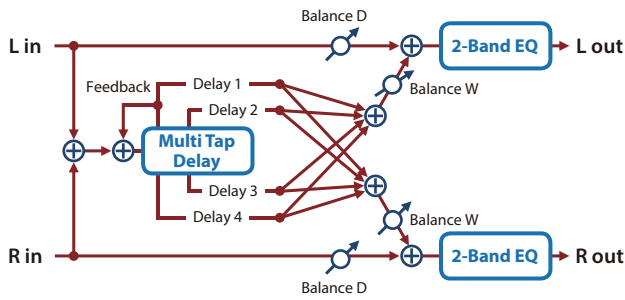

Parameter	Value	Explanation
Dly1 Level (Delay 1 Level)	0-127	Volume of each delay
Dly2 Level (Delay 2 Level)		
Dly3 Level (Delay 3 Level)		
Dly4 Level (Delay 4 Level)		
Low Gain	-15+15 [dB]	Amount of boost/cut for the low-frequency range
High Gain	-15+15 [dB]	Amount of boost/cut for the high-frequency range
Balance	D100: 0W-D0: 100W	Volume balance between the direct sound (D) and the effect sound (W)
Level	0-127	Output Level

Parameter	Value	Explanation
Dly1 Sync (Delay 1 Time sync switch))	OFF, ON	If this is ON, the rate synchronizes with the tempo of the rhythm. ➔ "Tempo" (p. 16)
D1. Time (Delay 1 Time (msec))	1-2600	Adjusts the time from the original sound until delay 1 sounds is heard.
D1Time Nt (Delay 1 Time (note))	Note ➔ "Note" (p. 64)	
Dly2 Sync (Delay 2 Time sync switch))	OFF, ON	If this is ON, the rate synchronizes with the tempo of the rhythm. ➔ "Tempo" (p. 16)
D2. Time (Delay 2 Time (msec))	1-2600	Adjusts the time from the original sound until delay 2 sounds is heard.
D2Time Nt (Delay 2 Time (note))	Note ➔ "Note" (p. 64)	
Dly3 Sync (Delay 3 Time sync switch))	OFF, ON	If this is ON, the rate synchronizes with the tempo of the rhythm. ➔ "Tempo" (p. 16)
D3. Time (Delay 3 Time (msec))	1-2600	Adjusts the time from the original sound until delay 3 sounds is heard.
D3Time Nt (Delay 3 Time (note))	Note ➔ "Note" (p. 64)	
Dly4 Sync (Delay 4 Time sync switch))	OFF, ON	If this is ON, the rate synchronizes with the tempo of the rhythm. ➔ "Tempo" (p. 16)
D4. Time (Delay 4 Time (msec))	1-2600	Adjusts the time from the original sound until delay 4 sounds is heard.
D4Time Nt (Delay 4 Time (note))	Note ➔ "Note" (p. 64)	
Dly1 Fbk (Delay 1 Feedback)	-98+98 [%]	Adjusts the proportion of the delay sound that is fed back into the effect. Negative (-) settings will invert the phase.
HF Damp	200, 250, 315, 400, 500, 630, 800, 1000, 1250, 1600, 2000, 2500, 3150, 4000, 5000, 6300, 8000, BYPASS [Hz]	Adjusts the frequency above which sound fed back to the effect is filtered out. If you don't want to filter out any high frequencies, set this parameter to BYPASS.
Dly1 Pan (Delay 1 Pan)	L64-63R	Stereo location of Delays 1-4
Dly2 Pan (Delay 2 Pan)		
Dly3 Pan (Delay 3 Pan)		
Dly4 Pan (Delay 4 Pan)		

Reverse Dly

This is a reverse delay that adds a reversed and delayed sound to the input sound. A tap delay is connected immediately after the reverse delay.

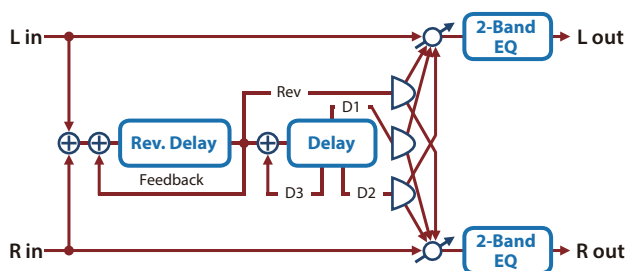

Parameter	Value	Explanation
Threshold	0–127	Volume at which the reverse delay will begin to be applied
RDly Sync (Reverse Delay Time sync switch))	OFF, ON	If this is ON, the rate synchronizes with the tempo of the rhythm. ➔ "Tempo" (p. 16)
RD Time (Reverse Delay Time (msec))	1–1300	Delay time from when sound is input into the reverse delay until the delay sound is heard
RD. Time Nt (Reverse Delay Time (note))	Note ➔ "Note" (p. 64)	
RDly Fbk (Reverse Delay Feedback)	-98–+98 [%]	Proportion of the delay sound that is to be returned to the input of the reverse delay negative (-) values invert the phase
RDly HF (Reverse Delay HF Damp)	200, 250, 315, 400, 500, 630, 800, 1000, 1250, 1600, 2000, 2500, 3150, 4000, 5000, 6300, 8000, BYPASS [Hz]	Frequency at which the high-frequency content of the reverse-delayed sound will be cut (BYPASS: no cut)
RDly Pan (Reverse Delay Pan)	L64–63R	Panning of the reverse delay sound
RDly Level (Reverse Delay Level)	0–127	Volume of the reverse delay sound
Dly1 Sync (Delay 1 Time sync switch))	OFF, ON	If this is ON, the rate synchronizes with the tempo of the rhythm. ➔ "Tempo" (p. 16)
D1. Time (Delay 1 Time (msec))	1–1300	Delay time from when sound is input into the tap delay until the delay sound is heard
D1Time Nt (Delay 1 Time (note))	Note ➔ "Note" (p. 64)	
Dly2 Sync (Delay 2 Time sync switch))	OFF, ON	If this is ON, the rate synchronizes with the tempo of the rhythm. ➔ "Tempo" (p. 16)
D2. Time (Delay 2 Time (msec))	1–1300	Delay time from when sound is input into the tap delay until the delay sound is heard
D2Time Nt (Delay 2 Time (note))	Note ➔ "Note" (p. 64)	
Dly3 Sync (Delay 3 Time sync switch))	OFF, ON	If this is ON, the rate synchronizes with the tempo of the rhythm. ➔ "Tempo" (p. 16)
D3. Time (Delay 3 Time (msec))	1–1300	Delay time from when sound is input into the tap delay until the delay sound is heard
D3Time Nt (Delay 3 Time (note))	Note ➔ "Note" (p. 64)	
Dly3 Fbk (Delay 3 Feedback)	-98–+98 [%]	Proportion of the delay sound that is to be returned to the input of the tap delay (negative (-) values invert the phase)

Parameter	Value	Explanation
Dly HF (Delay HF Damp)	200, 250, 315, 400, 500, 630, 800, 1000, 1250, 1600, 2000, 2500, 3150, 4000, 5000, 6300, 8000, BYPASS [Hz]	Frequency at which the high-frequency content of the tap delay sound will be cut (BYPASS: no cut)
Dly1 Pan (Delay 1 Pan)	L64–63R	Panning of the tap delay sounds
Dly2 Pan (Delay 2 Pan)	L64–63R	
Dly1 Lv (Delay 1 Level)	0–127	Volume of the tap delay sounds
Dly2 Lv (Delay 2 Level)	0–127	
Low Gain	-15–+15 [dB]	Amount of boost/cut for the low-frequency range
High Gain	-15–+15 [dB]	Amount of boost/cut for the high-frequency range
Balance	D100: 0W–D0: 100W	Volume balance between the direct sound (D) and the delay sound (W)
Level	0–127	Output Level

TimeCtrlDly (Time Control Delay)

A stereo delay in which the delay time can be varied smoothly.

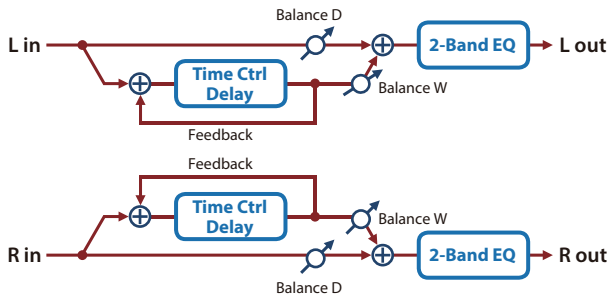

Parameter	Value	Explanation
Delay Sync (Delay Time (sync switch))	OFF, ON	If this is ON, the rate synchronizes with the tempo of the rhythm. ➔ "Tempo" (p. 16)
D. Time (Delay Time (msec))	1–1300	Adjusts the delay time from the direct sound until the delay sound is heard.
D. Time Nt (Delay Time (note))	Note ➔ "Note" (p. 64)	
Acceleration	0–15	Adjusts the speed which the Delay Time changes from the current setting to a specified new setting. The rate of change for the Delay Time directly affects the rate of pitch change.
Feedback	-98–+98 [%]	Adjusts the proportion of the delay sound that is fed back into the effect. Negative (-) settings will invert the phase.
HF Damp	200, 250, 315, 400, 500, 630, 800, 1000, 1250, 1600, 2000, 2500, 3150, 4000, 5000, 6300, 8000, BYPASS [Hz]	Adjusts the frequency above which sound fed back to the effect is filtered out. If you don't want to filter out any high frequencies, set this parameter to BYPASS.
Low Gain	-15–+15 [dB]	Amount of boost/cut for the low-frequency range
High Gain	-15–+15 [dB]	Amount of boost/cut for the high-frequency range
Balance	D100: 0W–D0: 100W	Volume balance between the direct sound (D) and the delay sound (W)
Level	0–127	Output Level

Tape Echo

A virtual tape echo that produces a realistic tape delay sound. This simulates the tape echo section of a Roland RE-201 Space Echo.

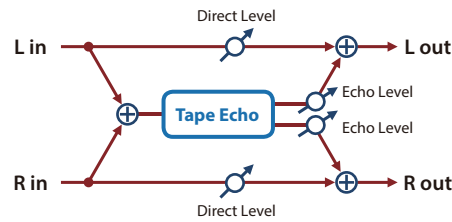

Parameter	Value	Explanation
Mode	S, M, L, S+M, S+L, M+L, S+M+L	Combination of playback heads to use Select from three different heads with different delay times. S: short M: middle L: long
Repeat Rate	0–127	Tape speed Increasing this value will shorten the spacing of the delayed sounds.
Intensity	0–127	Amount of delay repeats
Bass	-15–+15 [dB]	Boost/cut for the lower range of the echo sound
Treble	-15–+15 [dB]	Boost/cut for the upper range of the echo sound
Head S Pan	L64–63R	Independent panning for the short, middle, and long playback heads
Head M Pan	L64–63R	
Head L Pan	L64–63R	
Distortion (Tape Distortion)	0–5	Amount of tape-dependent distortion to be added This simulates the slight tonal changes that can be detected by signal-analysis equipment. Increasing this value will increase the distortion.
Wf Rate (W/F Rate)	0–127	Speed of wow/flutter (complex variation in pitch caused by tape wear and rotational irregularity)
Wf Depth (W/F Depth)	0–127	Depth of wow/flutter
Echo Level	0–127	Volume of the echo sound
Direct Lv	0–127	Volume of the original sound
Level	0–127	Output Level

LOFI Comp (Lo-Fi Compressor)

This is an effect that intentionally degrades the sound quality for creative purposes.

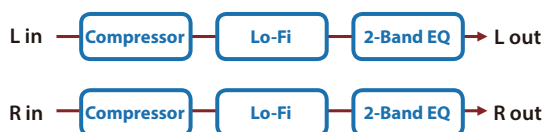

Parameter	Value	Explanation
Pre Filter (Pre Filter Type)	1, 2, 3, 4, 5, 6	Selects the type of filter applied to the sound before it passes through the Lo-Fi effect. 1: Compressor off 2-6: Compressor on
LoFi Type	1, 2, 3, 4, 5, 6, 7, 8, 9	Degrades the sound quality. The sound quality grows poorer as this value is increased.
Post Filter (Post Filter Type)	OFF, LPF, HPF	Type of filter OFF: No filter is used LPF: Cuts the frequency range above the Cutoff Freq HPF: Cuts the frequency range below the Cutoff Freq
Cutoff (Post Filter Cutoff)	200, 250, 315, 400, 500, 630, 800, 1000, 1250, 1600, 2000, 2500, 3150, 4000, 5000, 6300, 8000 [Hz]	Basic frequency of the Post Filter
Low Gain	-15~+15 [dB]	Amount of boost/cut for the low-frequency range
High Gain	-15~+15 [dB]	Amount of boost/cut for the high-frequency range
Balance	D100: 0W-D0: 100W	Volume balance between the direct sound (D) and the effect sound (W)
Level	0-127	Output Level

Bit Crasher

This creates a lo-fi sound.

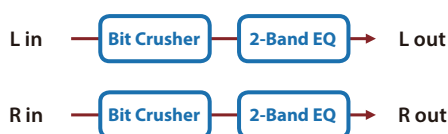

Parameter	Value	Explanation
Sample Rate	0-127	Adjusts the sample rate.
Bit Down	0-20	Adjusts the bit depth.
Filter	0-127	Adjusts the filter depth.
Low Gain	-15~+15 [dB]	Amount of boost/cut for the low-frequency range
High Gain	-15~+15 [dB]	Amount of boost/cut for the high-frequency range
Level	0-127	Output Level

PitchShiftr (Pitch Shifter)

A stereo pitch shifter.

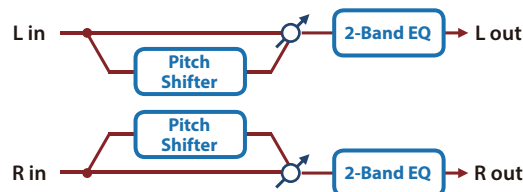

Parameter	Value	Explanation
Coarse	-24~+12 [semi]	Adjusts the pitch of the pitch shifted sound in semitone steps.
Fine	-100~+100 [cent]	Adjusts the pitch of the pitch shifted sound in 2-cent steps.
Delay Sync (Delay Time (sync switch))	OFF, ON	If this is ON, the rate synchronizes with the tempo of the rhythm. ➔ "Tempo" (p. 16)
D. Time (Delay Time (msec))	1-1300	Adjusts the delay time from the direct sound until the pitch shifted sound is heard.
D. Time Nt (Delay Time (note))	Note ➔ "Note" (p. 64)	
Feedback	-98~+98 [%]	Adjusts the proportion of the pitch shifted sound that is fed back into the effect. Negative (-) settings will invert the phase.
Low Gain	-15~+15 [dB]	Amount of boost/cut for the low-frequency range
High Gain	-15~+15 [dB]	Amount of boost/cut for the high-frequency range
Balance	D100: 0W-D0: 100W	Volume balance between the direct sound (D) and the pitch shifted sound (W)
Level	0-127	Output Level

2V PShifter (2 Voice Pitch Shifter)

Shifts the pitch of the original sound. This 2-voice pitch shifter has two pitch shifters, and can add two pitch shifted sounds to the original sound.

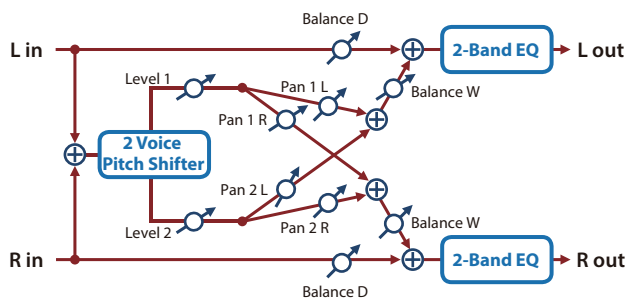

Parameter	Value	Explanation
P1 Coarse (Pitch1 Coarse)	-24--+12 [semi]	Adjusts the pitch of Pitch Shift 1 in semitone steps.
P1 Fine (Pitch1 Fine)	-100--+100 [cent]	Adjusts the pitch of Pitch Shift 1 in 2-cent steps.
P1 Dly Sync (Pitch1 Delay (sync switch))	OFF, ON	If this is ON, the rate synchronizes with the tempo of the rhythm. ➔ "Tempo" (p. 16)
P1 D. Time (Pitch1 Delay (msec))	1-1300	Adjusts the delay time from the direct sound until the Pitch Shift 1 sound is heard.
P1 DTime Nt (Pitch1 Delay (note))	Note ➔ "Note" (p. 64)	
P1 Feedback (Pitch1 Feedback)	-98--+98 [%]	Adjusts the proportion of the pitch shifted sound that is fed back into the effect. Negative (-) settings will invert the phase.
P1 Pan (Pitch1 Pan)	L64-63R	Stereo location of the Pitch Shift 1 sound
P1 Level (Pitch1 Level)	0-127	Volume of the Pitch Shift 1 sound
P2 Coarse (Pitch2 Coarse)	-24--+12 [semi]	Settings of the Pitch Shift 2 sound. The parameters are the same as for the Pitch Shift 1 sound.
P2 Fine (Pitch2 Fine)	-100--+100 [cent]	
P2 Dly Sync (Pitch2 Delay (sync switch))	OFF, ON	
P2 D. Time (Pitch2 Delay (msec))	1-1300	
P2 DTime Nt (Pitch2 Delay (note))	Note ➔ "Note" (p. 64)	
P2 Feedback (Pitch2 Feedback)	-98--+98 [%]	
P2 Pan (Pitch2 Pan)	L64-63R	
P2 Level (Pitch2 Level)	0-127	
Low Gain	-15--+15 [dB]	
High Gain	-15--+15 [dB]	Amount of boost/cut for the high-frequency range
Balance	D100: 0W-D0: 100W	Volume balance between the direct sound (D) and the pitch shifted sound (W)
Level	0-127	Output Level

OD → Chorus (Overdrive → Chorus)

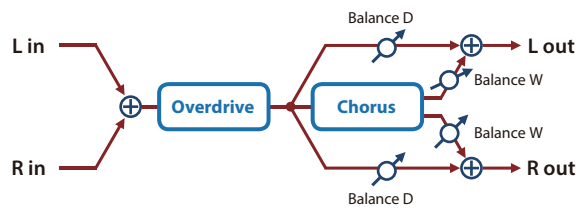

Parameter	Value	Explanation
OD Drive (Overdrive Drive)	0-127	Degree of distortion Also changes the volume.
OD Pan (Overdrive Pan)	L64-63R	Stereo location of the overdrive sound
Cho PreDly (Chorus Pre Delay)	0.0-100 [msec]	Adjusts the delay time from the direct sound until the chorus sound is heard.
Cho Sync (Chorus Rate (sync switch))	OFF, ON	If this is ON, the rate synchronizes with the tempo of the rhythm. ➔ "Tempo" (p. 16)
C. Rate (Chorus Rate (Hz))	0.05-10.00 [Hz]	Frequency of modulation
C. Rate Nt (Chorus Rate (note))	Note ➔ "Note" (p. 64)	
Cho Depth (Chorus Depth)	0-127	Depth of modulation
Cho Bal (Chorus Balance)	D100: 0W-D0: 100W	Adjusts the volume balance between the sound that is sent through the chorus (W) and the sound that is not sent through the chorus (D).
Level	0-127	Output Level

OD → Flanger (Overdrive → Flanger)

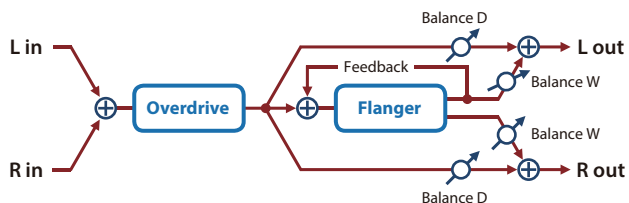

Parameter	Value	Explanation
OD Drive (Overdrive Drive)	0–127	Degree of distortion Also changes the volume.
OD Pan (Overdrive Pan)	L64–63R	Stereo location of the overdrive sound
Flg PreDly (Flanger Pre Delay)	0.0–100 [msec]	Adjusts the delay time from when the direct sound begins until the flanger sound is heard.
Flg Sync (Flanger Rate sync switch))	OFF, ON	If this is ON, the rate synchronizes with the tempo of the rhythm. ➔ "Tempo" (p. 16)
F. Delay (Flanger Rate (Hz))	0.05–10.00 [Hz]	Frequency of modulation
F. Rate Nt (Flanger Rate (note))	Note ➔ "Note" (p. 64)	
Flg Depth (Flanger Depth)	0–127	Depth of modulation
Flg Fbk (Flanger Feedback)	-98–+98 [%]	Adjusts the proportion of the flanger sound that is fed back into the effect. Negative (-) settings will invert the phase.
Flg Bal (Flanger Balance)	D100: 0W–D0: 100W	Adjusts the volume balance between the sound that is sent through the flanger (W) and the sound that is not sent through the flanger (D).
Level	0–127	Output Level

OD → Delay (Overdrive → Delay)

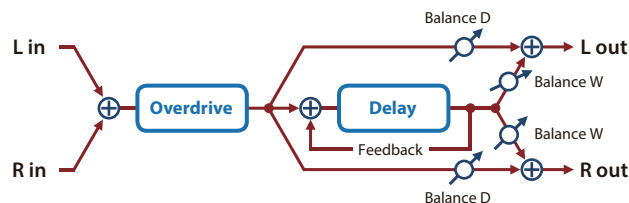

Parameter	Value	Explanation
OD Drive (Overdrive Drive)	0–127	Degree of distortion Also changes the volume.
OD Pan (Overdrive Pan)	L64–63R	Stereo location of the overdrive sound
Delay Sync (Delay Time sync switch))	OFF, ON	If this is ON, the rate synchronizes with the tempo of the rhythm. ➔ "Tempo" (p. 16)
D. Time (Delay Time (msec))	1–2600	Adjusts the delay time from the direct sound until the delay sound is heard.
D. Time Nt (Delay Time (note))	Note ➔ "Note" (p. 64)	
Delay Fbk (Delay Feedback)	-98–+98 [%]	Adjusts the proportion of the delay sound that is fed back into the effect. Negative (-) settings will invert the phase.
Dly HF (Delay HF Damp)	200, 250, 315, 400, 500, 630, 800, 1000, 1250, 1600, 2000, 2500, 3150, 4000, 5000, 6300, 8000, BYPASS [Hz]	Adjusts the frequency above which sound fed back to the effect will be cut. If you do not want to cut the high frequencies, set this parameter to BYPASS.
Dly Bal (Delay Balance)	D100: 0W–D0: 100W	Adjusts the volume balance between the sound that is sent through the delay (W) and the sound that is not sent through the delay (D).
Level	0–127	Output Level

DS → Chorus (Distortion → Chorus)

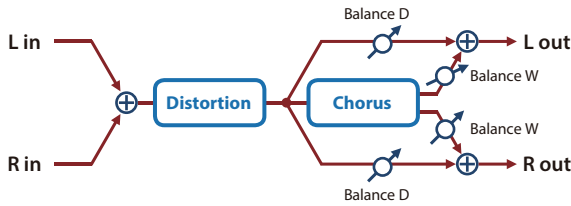

Parameter	Value	Explanation
Dist Drive (Distortion Drive)	0–127	Degree of distortion Also changes the volume.
Dist Pan (Distortion Pan)	L64–63R	Stereo location of the overdrive sound
Cho PreDly (Chorus Pre Delay)	0.0–100 [msec]	Adjusts the delay time from the direct sound until the chorus sound is heard.
Cho Sync (Chorus Rate sync switch)	OFF, ON	If this is ON, the rate synchronizes with the tempo of the rhythm. ➔ "Tempo" (p. 16)
C. Rate (Chorus Rate (Hz))	0.05–10.00 [Hz]	Frequency of modulation
C. Rate Nt (Chorus Rate (note))	Note ➔ "Note" (p. 64)	
Cho Depth (Chorus Depth)	0–127	Depth of modulation
Cho Bal (Chorus Balance)	D100: 0W–D0: 100W	Adjusts the volume balance between the sound that is sent through the chorus (W) and the sound that is not sent through the chorus (D).
Level	0–127	Output Level

DS → Flanger (Distortion → Flanger)

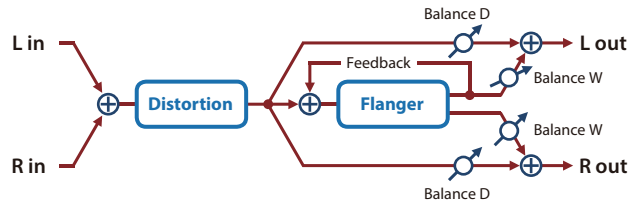

Parameter	Value	Explanation
Dist Drive (Distortion Drive)	0–127	Degree of distortion Also changes the volume.
Dist Pan (Distortion Pan)	L64–63R	Stereo location of the overdrive sound
Flg PreDly (Flanger Pre Delay)	0.0–100 [msec]	Adjusts the delay time from when the direct sound begins until the flanger sound is heard.
Flg Sync (Flanger Rate sync switch)	OFF, ON	If this is ON, the rate synchronizes with the tempo of the rhythm. ➔ "Tempo" (p. 16)
F. Delay (Flanger Rate (Hz))	0.05–10.00 [Hz]	Frequency of modulation
F. Rate Nt (Flanger Rate (note))	Note ➔ "Note" (p. 64)	
Flg Depth (Flanger Depth)	0–127	Depth of modulation
Flg Fbk (Flanger Feedback)	-98–+98 [%]	Adjusts the proportion of the flanger sound that is fed back into the effect. Negative (-) settings will invert the phase.
Flg Bal (Flanger Balance)	D100: 0W–D0: 100W	Adjusts the volume balance between the sound that is sent through the flanger (W) and the sound that is not sent through the flanger (D).
Level	0–127	Output Level

DS → Delay (Distortion → Delay)

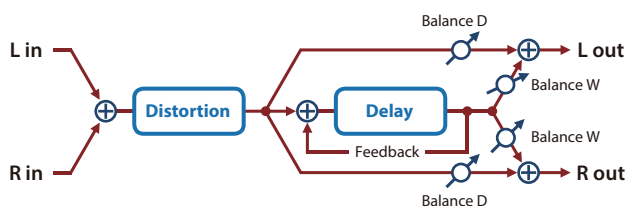

Parameter	Value	Explanation
Dist Drive (Distortion Drive)	0–127	Degree of distortion Also changes the volume.
Dist Pan (Distortion Pan)	L64–63R	Stereo location of the overdrive sound
Delay Sync (Delay Time (sync switch))	OFF, ON	If this is ON, the rate synchronizes with the tempo of the rhythm. → "Tempo" (p. 16)
D. Time (Delay Time (msec))	1–2600	Adjusts the delay time from the direct sound until the delay sound is heard.
D. Time Nt (Delay Time (note))	Note → "Note" (p. 64)	
Delay Fbk (Delay Feedback)	-98–+98 [%]	Adjusts the proportion of the delay sound that is fed back into the effect. Negative (-) settings will invert the phase.
Dly HF (Delay HF Damp)	200, 250, 315, 400, 500, 630, 800, 1000, 1250, 1600, 2000, 2500, 3150, 4000, 5000, 6300, 8000, BYPASS [Hz]	Adjusts the frequency above which sound fed back to the effect will be cut. If you do not want to cut the high frequencies, set this parameter to BYPASS.
Dly Bal (Delay Balance)	D100: 0W–D0: 100W	Adjusts the volume balance between the sound that is sent through the delay (W) and the sound that is not sent through the delay (D).
Level	0–127	Output Level

OD/DS → T. Wah (Overdrive/Distortion → Touch Wah)

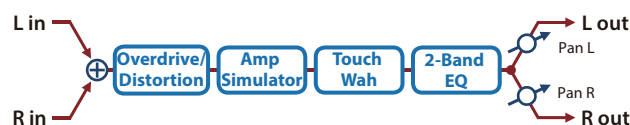

Parameter	Value	Explanation
Drive Switch	OFF, ON	Turns overdrive/distortion on/off
D. Type (Drive Type)	OVERDRIVE, DISTORTION	Type of distortion
Drive	0–127	Degree of distortion. Also changes the volume.
Tone	0–127	Sound quality of the Overdrive effect
Amp Switch	OFF, ON	Turns the Amp Simulator on/off.
AmpType (Amp Type)	SMALL, BUILT-IN, 2-STACK, 3-STACK	Type of guitar amp SMALL: Small amp BUILT-IN: Single-unit type amp 2-STACK: Large double stack amp 3-STACK: Large triple stack amp
TWah Switch (TouchWah Switch)	OFF, ON	Wah on/off
TWah Mode (TouchWah Mode)	LPF, BPF	Type of filter LPF: The wah effect will be applied over a wide frequency range. BPF: The wah effect will be applied over a narrow frequency range.
TWah Polar (TouchWah Polarity)	DOWN, UP	Direction in which the filter will move UP: The filter will change toward a higher frequency. DOWN: The filter will change toward a lower frequency.
TWah Sens (TouchWah Sens)	0–127	Sensitivity with which the filter is modified
TWah Manual (TouchWah Manual)	0–127	Center frequency at which the wah effect is applied
TWah Peak (TouchWah Peak)	0–127	Width of the frequency region at which the wah effect is applied Increasing this value will make the frequency region narrower.
TWah Bal (TouchWah Balance)	D100: 0W–D0: 100W	Adjusts the volume balance between the sound that is sent through the wah (W) and the sound that is not sent through the wah (D).
Low Gain	-15–+15 [dB]	Amount of boost/cut for the low-frequency range
High Gain	-15–+15 [dB]	Amount of boost/cut for the high-frequency range
Level	0–127	Output Level

OD/DS → A. Wah (Overdrive/Distortion
→ Auto Wah)



Parameter	Value	Explanation
Drive Switch	OFF, ON	Turns overdrive/distortion on/off
D. Type (Drive Type)	OVERDRIVE, DISTORTION	Type of distortion
Drive	0–127	Degree of distortion. Also changes the volume.
Tone	0–127	Sound quality of the Overdrive effect
Amp Switch	OFF, ON	Turns the Amp Simulator on/off.
AmpType (Amp Type)	SMALL, BUILT-IN, 2-STACK, 3-STACK	Type of guitar amp SMALL: Small amp BUILT-IN: Single-unit type amp 2-STACK: Large double stack amp 3-STACK: Large triple stack amp
AWah Switch (AutoWah Switch)	OFF, ON	Wah on/off
AWah Mode (AutoWah Mode)	LPF, BPF	Type of filter LPF: The wah effect will be applied over a wide frequency range. BPF: The wah effect will be applied over a narrow frequency range.
AWah Manual (AutoWah Manual)	0–127	Center frequency at which the wah effect is applied
AWah Peak (AutoWah Peak)	0–127	Width of the frequency region at which the wah effect is applied Increasing this value will make the frequency region narrower.
AWah Sync (AutoWah Rate sync switch)	OFF, ON	If this is ON, the rate synchronizes with the tempo of the rhythm. ➔ "Tempo" (p. 16)
AWRate (AutoWah Rate (Hz))	0.05–10.00 [Hz]	Frequency of modulation
AWRate Nt (AutoWah Rate (note))	Note ➔ "Note" (p. 64)	
AWah Depth (AutoWah Depth)	0–127	Depth at which the wah effect is modulated
AWah Bal (AutoWah Balance)	D100: 0W–D0: 100W	Adjusts the volume balance between the sound that is sent through the wah (W) and the sound that is not sent through the wah (D).
Low Gain	-15–+15 [dB]	Amount of boost/cut for the low-frequency range
High Gain	-15–+15 [dB]	Amount of boost/cut for the high-frequency range
Level	0–127	Output Level

Gt → Chorus (Guitar Amp Simulator → Chorus)

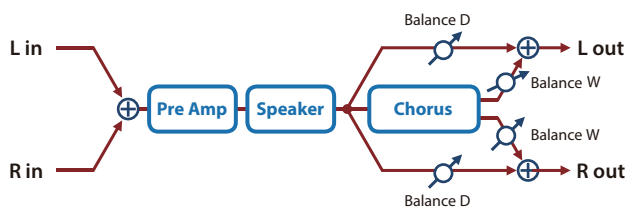

Parameter	Value	Explanation
Pre Amp Sw (Pre Amp Switch)	OFF, ON	Turns the amp switch on/off.
Type (Pre Amp Type)	Type of guitar amp	
	JC-120	This models the sound of the Roland JC-120.
	CLEAN TWIN	This models a Fender Twin Reverb.
	MATCH DRIVE	This models the sound input to left input on a Matchless D/C-30. A simulation of the latest tube amp widely used in styles from blues and rock.
	BG LEAD	This models the lead sound of the MESA/Boogie combo amp. The sound of a tube amp typical of the late '70s to '80s.
	MS1959I	This models the sound input to Input I on a Marshall 1959. This is a trebly sound suited to hard rock.
	MS1959II	This models the sound input to Input II on a Marshall 1959.
	MS1959I+II	The sound of connecting inputs I and II of the guitar amp in parallel, creating a sound with a stronger low end than I.
	SLDN LEAD	This models a Soldano SLO-100. This is the typical sound of the eighties.
	METAL 5150	This models the lead channel of a Peavey EVH 5150.
	METAL LEAD	This is distortion sound that is ideal for performances of heavy riffs.
	OD-1	This models the sound of the BOSS OD-1. This produces sweet, mild distortion.
	OD-2 TURBO	This is the high-gain overdrive sound of the BOSS OD-2.
	DISTORTION	This gives a basic, traditional distortion sound.
	FUZZ	A fuzz sound with rich harmonic content.
Drive (Pre Amp Drive)	0-127	Volume and amount of distortion of the amp
Master Lv (Pre Amp Master)	0-127	Volume of the entire pre-amp
Gain (Pre Amp Gain)	LOW, MIDDLE, HIGH	Amount of pre-amp distortion
Bass (Pre Amp Bass)	0-127	Tone of the bass/mid/treble frequency range Middle cannot be set if "MATCH DRIVE" is selected as the Pre Amp Type.
Middle (Pre Amp Middle)	0-127	
Treble (Pre Amp Treble)	0-127	
Speaker Sw (Speaker Switch)	OFF, ON	Selects whether the sound will be sent through the speaker simulation (ON) or not (OFF)

Parameter	Value	Explanation		
		Cabinet	Diameter (in inches) and number of the speaker	Microphone
SpType (Speaker Type)	SMALL 1	small open-back enclosure	10	dynamic
	SMALL 2	small open-back enclosure	10	dynamic
	MIDDLE	open back enclosure	12 x 1	dynamic
	JC-120	open back enclosure	12 x 2	dynamic
	BUILT-IN1	open back enclosure	12 x 2	dynamic
	BUILT-IN2	open back enclosure	12 x 2	condenser
	BUILT-IN3	open back enclosure	12 x 2	condenser
	BUILT-IN4	open back enclosure	12 x 2	condenser
	BUILT-IN5	open back enclosure	12 x 2	condenser
	BG STACK1	sealed enclosure	12 x 2	condenser
	BG STACK2	large sealed enclosure	12 x 2	condenser
	MS STACK1	large sealed enclosure	12 x 4	condenser
	MS STACK2	large sealed enclosure	12 x 4	condenser
	METAL STACK	large double stack	12 x 4	condenser
	2-STACK	large double stack	12 x 4	condenser
3-STACK	large triple stack	12 x 4	condenser	
Chorus Sw (Chorus Switch)	OFF, ON	Chorus on/off		
Cho PreDly (Chorus Pre Delay)	0.0-100 [msec]	Adjusts the delay time from the direct sound until the chorus sound is heard.		
C. Rate (Chorus Rate (Hz))	0.05-10.00 [Hz]	Frequency of modulation		
Cho Depth (Chorus Depth)	0-127	Depth of modulation		
Cho Bal (Chorus Balance)	D100: 0W-D0: 100W	Adjusts the volume balance between the sound that is sent through the chorus (W) and the sound that is not sent through the chorus (D).		
Level	0-127	Output Level		

GT → Flanger (Guitar Amp Simulator
→ Flanger)

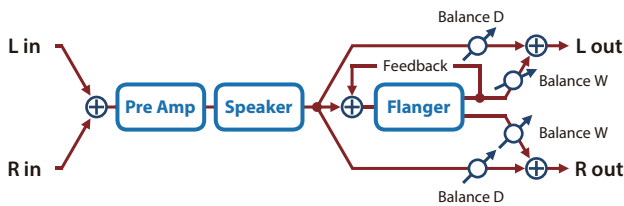

Parameter	Value	Explanation
Pre Amp Sw (Pre Amp Switch)	OFF, ON	Turns the amp switch on/off.
Type (Pre Amp Type)	Type of guitar amp	
	JC-120	This models the sound of the Roland JC-120.
	CLEAN TWIN	This models a Fender Twin Reverb.
	MATCH DRIVE	This models the sound input to left input on a Matchless D/C-30. A simulation of the latest tube amp widely used in styles from blues and rock.
	BG LEAD	This models the lead sound of the MESA/Boogie combo amp. The sound of a tube amp typical of the late '70s to '80s.
	MS1959I	This models the sound input to Input I on a Marshall 1959. This is a trebly sound suited to hard rock.
	MS1959II	This models the sound input to Input II on a Marshall 1959.
	MS1959I+II	The sound of connecting inputs I and II of the guitar amp in parallel, creating a sound with a stronger low end than I.
	SLDN LEAD	This models a Soldano SLO-100. This is the typical sound of the eighties.
	METAL 5150	This models the lead channel of a Peavey EVH 5150.
	METAL LEAD	This is distortion sound that is ideal for performances of heavy riffs.
	OD-1	This models the sound of the BOSS OD-1. This produces sweet, mild distortion.
	OD-2 TURBO	This is the high-gain overdrive sound of the BOSS OD-2.
	DISTORTION	This gives a basic, traditional distortion sound.
	FUZZ	A fuzz sound with rich harmonic content.
	Drive (Pre Amp Drive)	0-127
Master Lv (Pre Amp Master)	0-127	Volume of the entire pre-amp
Gain (Pre Amp Gain)	LOW, MIDDLE, HIGH	Amount of pre-amp distortion
Bass (Pre Amp Bass)	0-127	Tone of the bass/mid/treble frequency range Middle cannot be set if "MATCH DRIVE" is selected as the Pre Amp Type.
Middle (Pre Amp Middle)	0-127	
Treble (Pre Amp Treble)	0-127	
Speaker Sw (Speaker Switch)	OFF, ON	Selects whether the sound will be sent through the speaker simulation (ON) or not (OFF)

Parameter	Value	Explanation		
		Cabinet	Diameter (in inches) and number of the speaker	Microphone
SpType (Speaker Type)	SMALL 1	small open-back enclosure	10	dynamic
	SMALL 2	small open-back enclosure	10	dynamic
	MIDDLE	open back enclosure	12 x 1	dynamic
	JC-120	open back enclosure	12 x 2	dynamic
	BUILT-IN1	open back enclosure	12 x 2	dynamic
	BUILT-IN2	open back enclosure	12 x 2	condenser
	BUILT-IN3	open back enclosure	12 x 2	condenser
	BUILT-IN4	open back enclosure	12 x 2	condenser
	BUILT-IN5	open back enclosure	12 x 2	condenser
	BG STACK1	sealed enclosure	12 x 2	condenser
	BG STACK2	large sealed enclosure	12 x 2	condenser
	MS STACK1	large sealed enclosure	12 x 4	condenser
	MS STACK2	large sealed enclosure	12 x 4	condenser
	METAL STACK	large double stack	12 x 4	condenser
2-STACK	large double stack	12 x 4	condenser	
3-STACK	large triple stack	12 x 4	condenser	
Flg Switch (Flanger Switch)	OFF, ON	Flanger on/off		
Flg PreDly (Flanger Pre Delay)	0.0-100 [msec]	Adjusts the delay time from when the direct sound begins until the flanger sound is heard.		
F. Rate (Flanger Rate (Hz))	0.05-10.00 [Hz]	Frequency of modulation		
Flg Depth (Flanger Depth)	0-127	Depth of modulation		
Flg Fbk (Flanger Feedback)	-98-+98 [%]	Adjusts the proportion of the flanger sound that is fed back into the effect. Negative (-) settings will invert the phase.		
Flg Bal (Flanger Balance)	D100: 0W-D0: 100W	Adjusts the volume balance between the sound that is sent through the flanger (W) and the sound that is not sent through the flanger (D).		
Level	0-127	Output Level		

Gt → Phaser (Guitar Amp Simulator → Phaser)

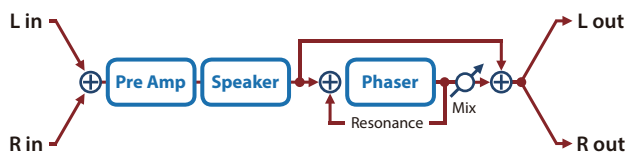

Parameter	Value	Explanation
Pre Amp Sw (Pre Amp Switch)	OFF, ON	Turns the amp switch on/off.
Type (Pre Amp Type)	Type of guitar amp	
	JC-120	This models the sound of the Roland JC-120.
	CLEAN TWIN	This models a Fender Twin Reverb.
	MATCH DRIVE	This models the sound input to left input on a Matchless D/C-30. A simulation of the latest tube amp widely used in styles from blues and rock.
	BG LEAD	This models the lead sound of the MESA/Boogie combo amp. The sound of a tube amp typical of the late '70s to '80s.
	MS1959I	This models the sound input to Input I on a Marshall 1959. This is a trebly sound suited to hard rock.
	MS1959II	This models the sound input to Input II on a Marshall 1959.
	MS1959I+II	The sound of connecting inputs I and II of the guitar amp in parallel, creating a sound with a stronger low end than I.
	SLDN LEAD	This models a Soldano SLO-100. This is the typical sound of the eighties.
	METAL 5150	This models the lead channel of a Peavey EVH 5150.
	METAL LEAD	This is distortion sound that is ideal for performances of heavy riffs.
	OD-1	This models the sound of the BOSS OD-1. This produces sweet, mild distortion.
	OD-2 TURBO	This is the high-gain overdrive sound of the BOSS OD-2.
	DISTORTION	This gives a basic, traditional distortion sound.
	FUZZ	A fuzz sound with rich harmonic content.
	Drive (Pre Amp Drive)	0–127
Master Lv (Pre Amp Master)	0–127	Volume of the entire pre-amp
Gain (Pre Amp Gain)	LOW, MIDDLE, HIGH	Amount of pre-amp distortion
Bass (Pre Amp Bass)	0–127	Tone of the bass/mid/treble frequency range Middle cannot be set if "MATCH DRIVE" is selected as the Pre Amp Type.
Middle (Pre Amp Middle)	0–127	
Treble (Pre Amp Treble)	0–127	
Speaker Sw (Speaker Switch)	OFF, ON	Selects whether the sound will be sent through the speaker simulation (ON) or not (OFF)

Parameter	Value	Explanation		
		Cabinet	Diameter (in inches) and number of the speaker	Microphone
SpType (Speaker Type)	SMALL 1	small open-back enclosure	10	dynamic
	SMALL 2	small open-back enclosure	10	dynamic
	MIDDLE	open back enclosure	12 x 1	dynamic
	JC-120	open back enclosure	12 x 2	dynamic
	BUILT-IN1	open back enclosure	12 x 2	dynamic
	BUILT-IN2	open back enclosure	12 x 2	condenser
	BUILT-IN3	open back enclosure	12 x 2	condenser
	BUILT-IN4	open back enclosure	12 x 2	condenser
	BUILT-IN5	open back enclosure	12 x 2	condenser
	BG STACK1	sealed enclosure	12 x 2	condenser
	BG STACK2	large sealed enclosure	12 x 2	condenser
	MS STACK1	large sealed enclosure	12 x 4	condenser
	MS STACK2	large sealed enclosure	12 x 4	condenser
	METAL STACK	large double stack	12 x 4	condenser
	2-STACK	large double stack	12 x 4	condenser
3-STACK	large triple stack	12 x 4	condenser	
Phaser SW (Phaser Switch)	OFF, ON	Phaser on/off		
P. Rate (Phaser Rate (Hz))	0.05–10.00 [Hz]	Frequency of modulation		
Phs Manual (Phaser Manual)	0–127	Adjusts the basic frequency from which the sound will be modulated.		
Phs Depth (Phaser Depth)	0–127	Depth of modulation		
Phs Reso (Phaser Resonance)	0–127	Amount of feedback		
Phs Mix (Phaser Mix)	0–127	Level of the phase-shifted sound		
Level	0–127	Output Level		

Gt → Delay (Guitar Amp Simulator → Delay)

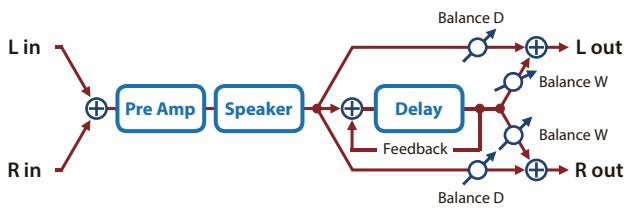

Parameter	Value	Explanation
Pre Amp Sw (Pre Amp Switch)	OFF, ON	Turns the amp switch on/off.
Type (Pre Amp Type)	Type of guitar amp	
	JC-120	This models the sound of the Roland JC-120.
	CLEAN TWIN	This models a Fender Twin Reverb.
	MATCH DRIVE	This models the sound input to left input on a Matchless D/C-30. A simulation of the latest tube amp widely used in styles from blues and rock.
	BG LEAD	This models the lead sound of the MESA/Boogie combo amp. The sound of a tube amp typical of the late '70s to '80s.
	MS1959I	This models the sound input to Input I on a Marshall 1959. This is a trebly sound suited to hard rock.
	MS1959II	This models the sound input to Input II on a Marshall 1959.
	MS1959I+II	The sound of connecting inputs I and II of the guitar amp in parallel, creating a sound with a stronger low end than I.
	SLDN LEAD	This models a Soldano SLO-100. This is the typical sound of the eighties.
	METAL 5150	This models the lead channel of a Peavey EVH 5150.
	METAL LEAD	This is distortion sound that is ideal for performances of heavy riffs.
	OD-1	This models the sound of the BOSS OD-1. This produces sweet, mild distortion.
	OD-2 TURBO	This is the high-gain overdrive sound of the BOSS OD-2.
	DISTORTION	This gives a basic, traditional distortion sound.
	FUZZ	A fuzz sound with rich harmonic content.
	Drive (Pre Amp Drive)	0-127
Master Lv (Pre Amp Master)	0-127	Volume of the entire pre-amp
Gain (Pre Amp Gain)	LOW, MIDDLE, HIGH	Amount of pre-amp distortion
Bass (Pre Amp Bass)	0-127	Tone of the bass/mid/treble frequency range Middle cannot be set if "MATCH DRIVE" is selected as the Pre Amp Type.
Middle (Pre Amp Middle)	0-127	
Treble (Pre Amp Treble)	0-127	
Speaker Sw (Speaker Switch)	OFF, ON	Selects whether the sound will be sent through the speaker simulation (ON) or not (OFF)

Parameter	Value	Explanation		
		Cabinet	Diameter (in inches) and number of the speaker	Microphone
SpType (Speaker Type)	SMALL 1	small open-back enclosure	10	dynamic
	SMALL 2	small open-back enclosure	10	dynamic
	MIDDLE	open back enclosure	12 x 1	dynamic
	JC-120	open back enclosure	12 x 2	dynamic
	BUILT-IN1	open back enclosure	12 x 2	dynamic
	BUILT-IN2	open back enclosure	12 x 2	condenser
	BUILT-IN3	open back enclosure	12 x 2	condenser
	BUILT-IN4	open back enclosure	12 x 2	condenser
	BUILT-IN5	open back enclosure	12 x 2	condenser
	BG STACK1	sealed enclosure	12 x 2	condenser
	BG STACK2	large sealed enclosure	12 x 2	condenser
	MS STACK1	large sealed enclosure	12 x 4	condenser
	MS STACK2	large sealed enclosure	12 x 4	condenser
	MTL STACK	large double stack	12 x 4	condenser
	2-STACK	large double stack	12 x 4	condenser
3-STACK	large triple stack	12 x 4	condenser	
Delay Sw (Delay Switch)	OFF, ON	Delay on/off		
Dly Time (Delay Time)	1-1300	Adjusts the delay time from the direct sound until the delay sound is heard.		
Delay Fbk (Delay Feedback)	-98-+98 [%]	Adjusts the proportion of the delay sound that is fed back into the effect. Negative (-) settings will invert the phase.		
Dly HF (Delay HF Damp)	200, 250, 315, 400, 500, 630, 800, 1000, 1250, 1600, 2000, 2500, 3150, 4000, 5000, 6300, 8000, BYPASS [Hz]	Frequency at which the high-frequency portion of the delay sound will be cut (BYPASS: no cut)		
Dly Bal (Delay Balance)	D100: 0W-D0: 100W	Adjusts the volume balance between the sound that is sent through the delay (W) and the sound that is not sent through the delay (D).		
Level	0-127	Output Level		

EP → Tremolo (EP Amp Simulator → Tremolo)

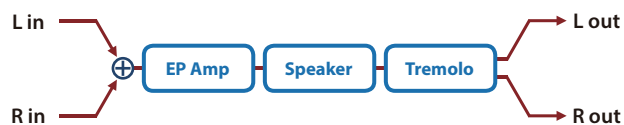

Parameter	Value	Explanation
Type		Type of amp
	OLDCASE	A standard electric piano sound of the early 70s
	NEWCASE	A standard electric piano sound of the late 70s and early 80s
	WURLY	A standard electric piano sound of the 60s
Bass	-50~+50	Amount of low-frequency boost/cut
Treble	-50~+50	Amount of high-frequency boost/cut
Tremolo Sw (Tremolo Switch)	OFF, ON	Tremolo on/off
Tremolo Sync (Tremolo Speed (sync switch))	OFF, ON	If this is ON, the rate synchronizes with the tempo of the rhythm. → "Tempo" (p. 16)
T. Speed (Tremolo Speed (Hz))	0.05~10.00 [Hz]	Rate of the tremolo effect
T. Spd Nt (Tremolo Speed (note))	Note → "Note" (p. 64)	
Trm Depth (Tremolo Depth)	0~127	Depth of the tremolo effect
Trm Duty (Tremolo Duty)	-10~+10	Adjusts the duty cycle of the LFO waveform used to apply tremolo.
Sp Type (Speaker Type)	LINE, OLD, NEW, WURLY, TWIN	Type of speaker If LINE is selected, the sound will not be sent through the speaker simulation.
OD Switch (Overdrive Switch)	OFF, ON	Overdrive on/off
OD Gain (Overdrive Gain)	0~127	Overdrive input level
OD Drive (Overdrive Drive)	0~127	Degree of distortion
Level	0~127	Output Level

EP → Chorus (EP Amp Simulator → Chorus)

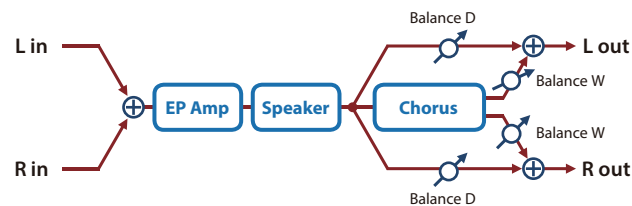

Parameter	Value	Explanation
Type		Type of amp
	OLDCASE	A standard electric piano sound of the early 70s
	NEWCASE	A standard electric piano sound of the late 70s and early 80s
Bass	-50~+50	Amount of low-frequency boost/cut
Treble	-50~+50	Amount of high-frequency boost/cut
Cho Switch (Chorus Switch)	OFF, ON	Chorus on/off
Cho Predly (Chorus Pre Delay)	0.0~100 [msec]	Adjusts the delay time from the direct sound until the chorus sound is heard.
Cho Sync (Chorus Rate (sync switch))	OFF, ON	If this is ON, the rate synchronizes with the tempo of the rhythm. → "Tempo" (p. 16)
C. Rate (Chorus Rate (Hz))	0.05~10.00 [Hz]	Frequency of modulation
C. Rate Nt (Chorus Rate (note))	Note → "Note" (p. 64)	
Cho Depth (Chorus Depth)	0~127	Depth of modulation
Cho Bal (Chorus Balance)	D100: 0W~D0: 100W	Adjusts the volume balance between the sound that is sent through the chorus (W) and the sound that is not sent through the chorus (D).
Sp Type (Speaker Type)	LINE, OLD, NEW, WURLY, TWIN	Type of speaker If LINE is selected, the sound will not be sent through the speaker simulation.
OD Switch (Overdrive Switch)	OFF, ON	Overdrive on/off
OD Gain (Overdrive Gain)	0~127	Overdrive input level
OD Drive (Overdrive Drive)	0~127	Degree of distortion
Level	0~127	Output Level

EP → Flanger (EP Amp Simulator → Flanger)

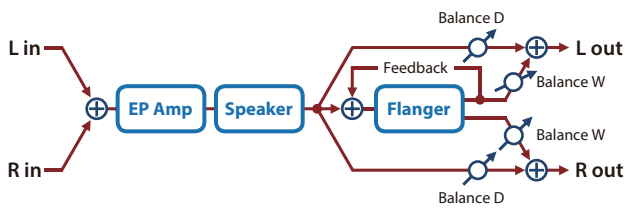

Parameter	Value	Explanation
Type		Type of amp
	OLDCASE	A standard electric piano sound of the early 70s
	NEWCASE	A standard electric piano sound of the late 70s and early 80s
Bass	-50→+50	Amount of low-frequency boost/cut
Treble	-50→+50	Amount of high-frequency boost/cut
Flg Switch (Flanger Switch)	OFF, ON	Flanger on/off
Flg PreDly (Flanger Pre Delay)	0.0–100 [msec]	Adjusts the delay time from when the direct sound begins until the flanger sound is heard.
Flg Sync (Flanger Rate sync switch))	OFF, ON	If this is ON, the rate synchronizes with the tempo of the rhythm. ➔ "Tempo" (p. 16)
F. Rate (Flanger Rate (Hz))	0.05–10.00 [Hz]	Frequency of modulation
F. Rate Nt (Flanger Rate (note))	Note ➔ "Note" (p. 64)	
Flg Depth (Flanger Depth)	0–127	Depth of modulation
Flg Fbk (Flanger Feedback)	-98→+98 [%]	Adjusts the proportion of the flanger sound that is fed back into the effect. Negative (-) settings will invert the phase.
Flg Bal (Flanger Balance)	D100: 0W–D0: 100W	Adjusts the volume balance between the sound that is sent through the flanger (W) and the sound that is not sent through the flanger (D).
Sp Type (Speaker Type)	LINE, OLD, NEW, WURLY, TWIN	Type of speaker If LINE is selected, the sound will not be sent through the speaker simulation.
OD Switch (Overdrive Switch)	OFF, ON	Overdrive on/off
OD Gain (Overdrive Gain)	0–127	Overdrive input level
OD Drive (Overdrive Drive)	0–127	Degree of distortion
Level	0–127	Output Level

EP → Phaser (EP Amp Simulator → Phaser)

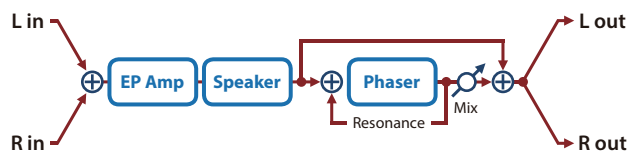

Parameter	Value	Explanation
Type		Type of amp
	OLDCASE	A standard electric piano sound of the early 70s
	NEWCASE	A standard electric piano sound of the late 70s and early 80s
Bass	-50→+50	Amount of low-frequency boost/cut
Treble	-50→+50	Amount of high-frequency boost/cut
Phs Switch (Phaser Switch)	OFF, ON	Phaser on/off
Phs Sync (Phaser Rate sync switch))	OFF, ON	If this is ON, the rate synchronizes with the tempo of the rhythm. ➔ "Tempo" (p. 16)
P. Rate (Phaser Rate (Hz))	0.05–10.00 [Hz]	Frequency of modulation
P. Rate Nt (Phaser Rate (note))	Note ➔ "Note" (p. 64)	
Phs Manual (Phaser Manual)	0–127	Adjusts the basic frequency from which the sound will be modulated.
Phs Depth (Phaser Depth)	0–127	Depth of modulation
Phs Reso (Phaser Resonance)	0–127	Amount of feedback
Phs Mix (Phaser Mix)	0–127	Level of the phase-shifted sound
Sp Type (Speaker Type)	LINE, OLD, NEW, WURLY, TWIN	Type of speaker If LINE is selected, the sound will not be sent through the speaker simulation.
OD Switch (Overdrive Switch)	OFF, ON	Overdrive on/off
OD Gain (Overdrive Gain)	0–127	Overdrive input level
OD Drive (Overdrive Drive)	0–127	Degree of distortion
Level	0–127	Output Level

EP → Delay (EP Amp Simulator → Delay)

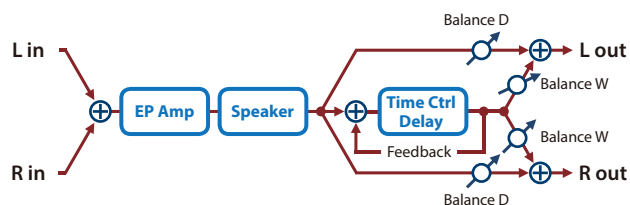

Parameter	Value	Explanation
Type		Type of amp
	OLDCASE	A standard electric piano sound of the early 70s
	NEWCASE	A standard electric piano sound of the late 70s and early 80s
Bass	-50+50	Amount of low-frequency boost/cut
Treble	-50+50	Amount of high-frequency boost/cut
Dly Switch (Delay Switch)	OFF, ON	Delay on/off
Delay Sync (Delay Time sync switch)	OFF, ON	If this is ON, the rate synchronizes with the tempo of the rhythm. ➔ "Tempo" (p. 16)
D. Time (Delay Time (msec))	1-1300	Adjusts the delay time from the direct sound until the delay sound is heard.
D. Time Nt (Delay Time (note))	Note ➔ "Note" (p. 64)	
Dly Accel (Delay Accel)	0-15	Speed at which the current delay time changes to the specified delay time when you change the delay time. The speed of the pitch change will change simultaneously with the delay time.
Delay Fbk (Delay Feedback)	-98+98 [%]	Adjusts the proportion of the delay sound that is fed back into the effect. Negative (-) settings will invert the phase.
Dly HF (Delay HF Damp)	200, 250, 315, 400, 500, 630, 800, 1000, 1250, 1600, 2000, 2500, 3150, 4000, 5000, 6300, 8000, BYPASS [Hz]	Frequency at which the high-frequency portion of the delay sound will be cut (BYPASS: no cut)
Dly Bal (Delay Balance)	D100: 0W-D0: 100W	Adjusts the volume balance between the sound that is sent through the delay (W) and the sound that is not sent through the delay (D).
Sp Type (Speaker Type)	LINE, OLD, NEW, WURLY, TWIN	Type of speaker If LINE is selected, the sound will not be sent through the speaker simulation.
OD Switch (Overdrive Switch)	OFF, ON	Overdrive on/off
OD Gain (Overdrive Gain)	0-127	Overdrive input level
OD Drive (Overdrive Drive)	0-127	Degree of distortion
Level	0-127	Output Level

Enhncr → Cho (Enhancer → Chorus)

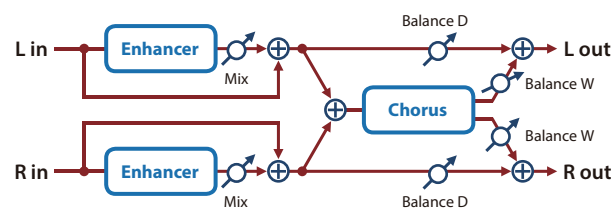

Parameter	Value	Explanation
Enh Sens (Enhancer Sens)	0-127	Sensitivity of the enhancer
Enh Mix (Enhancer Mix)	0-127	Level of the overtones generated by the enhancer
Cho PreDly (Chorus Pre Delay)	0.0-100 [msec]	Adjusts the delay time from the direct sound until the chorus sound is heard.
Cho Sync (Chorus Rate sync switch)	OFF, ON	If this is ON, the rate synchronizes with the tempo of the rhythm. ➔ "Tempo" (p. 16)
C. Rate (Chorus Rate (Hz))	0.05-10.00 [Hz]	Frequency of modulation
C. Rate Nt (Chorus Rate (note))	Note ➔ "Note" (p. 64)	
Cho Depth (Chorus Depth)	0-127	Depth of modulation
Cho Bal (Chorus Balance)	D100: 0W-D0: 100W	Adjusts the volume balance between the sound that is sent through the chorus (W) and the sound that is not sent through the chorus (D).
Level	0-127	Output Level

Enhncr → Fl (Enhancer → Flanger)

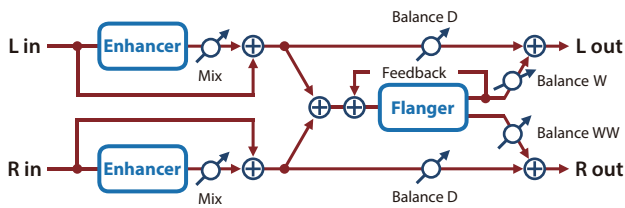

Parameter	Value	Explanation
Enh Sens (Enhancer Sens)	0–127	Sensitivity of the enhancer
Enh Mix (Enhancer Mix)	0–127	Level of the overtones generated by the enhancer
Flg PreDly (Flanger Pre Delay)	0.0–100 [msec]	Adjusts the delay time from when the direct sound begins until the flanger sound is heard.
Flg Sync (Flanger Rate sync switch)	OFF, ON	If this is ON, the rate synchronizes with the tempo of the rhythm. ➔ "Tempo" (p. 16)
F. Rate (Flanger Rate (Hz))	0.05–10.00 [Hz]	Frequency of modulation
F. Rate Nt (Flanger Rate (note))	Note ➔ "Note" (p. 64)	
Flg Depth (Flanger Depth)	0–127	Depth of modulation
Flg Fbk (Flanger Feedback)	-98–+98 [%]	Adjusts the proportion of the flanger sound that is fed back into the effect. Negative (-) settings will invert the phase.
Flg Bal (Flanger Balance)	D100: 0W–D0: 100W	Adjusts the volume balance between the sound that is sent through the flanger (W) and the sound that is not sent through the flanger (D).
Level	0–127	Output Level

Enhncr → Dly (Enhancer0 Delay)

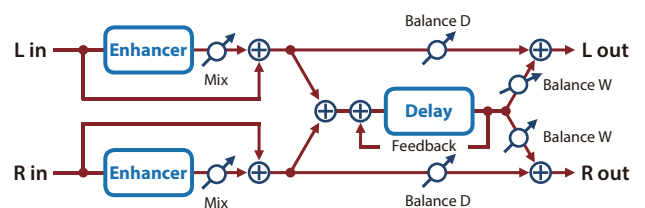

Parameter	Value	Explanation
Enh Sens (Enhancer Sens)	0–127	Sensitivity of the enhancer
Enh Mix (Enhancer Mix)	0–127	Level of the overtones generated by the enhancer
Dly Sync (Delay Time sync switch)	OFF, ON	If this is ON, the rate synchronizes with the tempo of the rhythm. ➔ "Tempo" (p. 16)
D. Time (Delay Time (msec))	1–2600	Adjusts the delay time from the direct sound until the delay sound is heard.
D. Time Nt (Delay Time (note))	Note ➔ "Note" (p. 64)	
Delay Fbk (Delay Feedback)	-98–+98 [%]	Adjusts the proportion of the delay sound that is fed back into the effect. Negative (-) settings will invert the phase.
Dly HF (Delay HF Damp)	200, 250, 315, 400, 500, 630, 800, 1000, 1250, 1600, 2000, 2500, 3150, 4000, 5000, 6300, 8000, BYPASS [Hz]	Adjusts the frequency above which sound fed back to the effect will be cut. If you do not want to cut the high frequencies, set this parameter to BYPASS.
Dly Bal (Delay Balance)	D100: 0W–D0: 100W	Adjusts the volume balance between the sound that is sent through the delay (W) and the sound that is not sent through the delay (D).
Level	0–127	Output Level

Chorus → Dly (Chorus → Delay)

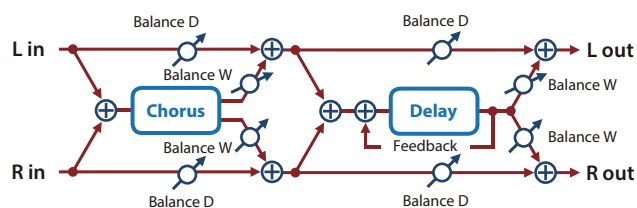

Parameter	Value	Explanation
Cho PreDly (Chorus Pre Delay)	0.0–100 [msec]	Adjusts the delay time from the direct sound until the chorus sound is heard.
Cho Sync (Chorus Rate (sync switch))	OFF, ON	If this is ON, the rate synchronizes with the tempo of the rhythm. ➔ "Tempo" (p. 16)
C. Rate (Chorus Rate (Hz))	0.05–10.00 [Hz]	Frequency of modulation
C. Rate Nt (Chorus Rate (note))	Note ➔ "Note" (p. 64)	
Cho Depth (Chorus Depth)	0–127	Depth of modulation
Cho Bal (Chorus Balance)	D100: 0W–D0: 100W	Volume balance between the direct sound (D) and the chorus sound (W)
Delay Sync (Delay Time (sync switch))	OFF, ON	If this is ON, the rate synchronizes with the tempo of the rhythm. ➔ "Tempo" (p. 16)
D. Time (Delay Time (msec))	1–2600	Adjusts the delay time from the direct sound until the delay sound is heard.
D. Time Nt (Delay Time (note))	Note ➔ "Note" (p. 64)	
Delay Fbk (Delay Feedback)	-98–+98 [%]	Adjusts the proportion of the delay sound that is fed back into the effect. Negative (-) settings will invert the phase.
Dly HF (Delay HF Damp)	200, 250, 315, 400, 500, 630, 800, 1000, 1250, 1600, 2000, 2500, 3150, 4000, 5000, 6300, 8000, BYPASS [Hz]	Adjusts the frequency above which sound fed back to the effect will be cut. If you do not want to cut the high frequencies, set this parameter to BYPASS.
Dly Bal (Delay Balance)	D100: 0W–D0: 100W	Adjusts the volume balance between the sound that is sent through the delay (W) and the sound that is not sent through the delay (D).
Level	0–127	Output Level

Flanger → Dly (Flanger → Delay)

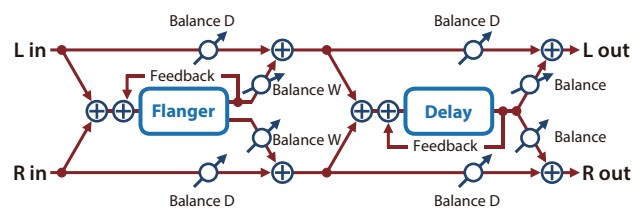

Parameter	Value	Explanation
Flg PreDly (Flanger Pre Delay)	0.0–100 [msec]	Adjusts the delay time from when the direct sound begins until the flanger sound is heard.
Flg Sync (Flanger Rate (sync switch))	OFF, ON	If this is ON, the rate synchronizes with the tempo of the rhythm. ➔ "Tempo" (p. 16)
F. Rate (Flanger Rate (Hz))	0.05–10.00 [Hz]	Frequency of modulation
F. Rate Nt (Flanger Rate (note))	Note ➔ "Note" (p. 64)	
Flg Depth (Flanger Depth)	0–127	Depth of modulation
Flg Fbk (Flanger Feedback)	-98–+98 [%]	Adjusts the proportion of the flanger sound that is fed back into the effect. Negative (-) settings will invert the phase.
Flg Bal (Flanger Balance)	D100: 0W–D0: 100W	Volume balance between the direct sound (D) and the flanger sound (W)
Delay Sync (Delay Time (sync switch))	OFF, ON	If this is ON, the rate synchronizes with the tempo of the rhythm. ➔ "Tempo" (p. 16)
D. Time (Delay Time (msec))	1–2600	Adjusts the delay time from the direct sound until the delay sound is heard.
D. Time Nt (Delay Time (note))	Note ➔ "Note" (p. 64)	
Delay Fbk (Delay Feedback)	-98–+98 [%]	Adjusts the proportion of the delay sound that is fed back into the effect. Negative (-) settings will invert the phase.
Dly HF (Delay HF Damp)	200, 250, 315, 400, 500, 630, 800, 1000, 1250, 1600, 2000, 2500, 3150, 4000, 5000, 6300, 8000, BYPASS [Hz]	Adjusts the frequency above which sound fed back to the effect will be cut. If you do not want to cut the high frequencies, set this parameter to BYPASS.
Dly Bal (Delay Balance)	D100: 0W–D0: 100W	Adjusts the volume balance between the sound that is sent through the delay (W) and the sound that is not sent through the delay (D).
Level	0–127	Output Level

Chorus → Fl (Chorus → Flanger)

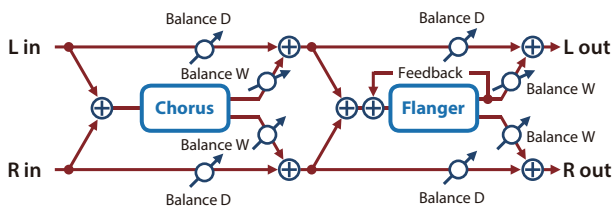

Parameter	Value	Explanation
Cho PreDly (Chorus Pre Delay)	0.0–100 [msec]	Adjusts the delay time from the direct sound until the chorus sound is heard.
Cho Sync (Chorus Rate sync switch)	OFF, ON	If this is ON, the rate synchronizes with the tempo of the rhythm. ➔ “Tempo” (p. 16)
C. Rate (Chorus Rate (Hz))	0.05–10.00 [Hz]	Modulation frequency of the chorus effect
C. Rate Nt (Chorus Rate (note))	Note ➔ “Note” (p. 64)	
Cho Depth (Chorus Depth)	0–127	Modulation depth of the chorus effect
Cho Bal (Chorus Balance)	D100: 0W–D0: 100W	Volume balance between the direct sound (D) and the chorus sound (W)
Flg PreDly (Flanger Pre Delay)	0.0–100 [msec]	Adjusts the delay time from when the direct sound begins until the flanger sound is heard.
Flg Sync (Flanger Rate sync switch)	OFF, ON	If this is ON, the rate synchronizes with the tempo of the rhythm. ➔ “Tempo” (p. 16)
F. Rate (Flanger Rate (Hz))	0.05–10.00 [Hz]	Modulation frequency of the flanger effect
F. Rate Nt (Flanger Rate (note))	Note ➔ “Note” (p. 64)	
Flg Depth (Flanger Depth)	0–127	Modulation depth of the flanger effect
Flg Fbk (Flanger Feedback)	-98–+98 [%]	Adjusts the proportion of the flanger sound that is fed back into the effect. Negative (-) settings will invert the phase.
Flg Bal (Flanger Balance)	D100: 0W–D0: 100W	Adjusts the volume balance between the sound that is sent through the flanger (W) and the sound that is not sent through the flanger (D).
Level	0–127	Output Level

CE-1 (Chorus)

This models the classic BOSS CE-1 chorus effect unit. It provides a chorus sound with a distinctively analog warmth.



Parameter	Value	Explanation
Intensity	0–127	Chorus depth
Low Gain	-15–+15 [dB]	Amount of boost/cut for the low-frequency range
High Gain	-15–+15 [dB]	Amount of boost/cut for the high-frequency range
Level	0–127	Output Level

SBF-325 (Flanger)

This effect reproduces Roland’s SBF-325 analog flanger. It provides three types of flanging effect (which adds a metallic resonance to the original sound) and a chorus-type effect.



Parameter	Value	Explanation
Mode		Types of flanging effect
	FL1	A typical mono flanger
	FL2	A stereo flanger that preserves the stereo positioning of the original sound
	FL3	A cross-mix flanger that produces a more intense effect
	CHO	A chorus effect
Rate Sync (Rate sync switch)	OFF, ON	If this is ON, the rate synchronizes with the tempo of the rhythm. ➔ “Tempo” (p. 16)
Rate (Rate (Hz))	0.02–5.00 [Hz]	Modulation frequency of the flanger effect
Rate Note (Rate (note))	Note ➔ “Note” (p. 64)	
Depth	0–127	Modulation depth of the flanger effect
Manual	0–127	Center frequency at which the flanger effect is applied
Feedback	0–127	Amount by which the flanging effect is boosted
		If Mode is CHO, this setting is ignored.
RMod Phase (CH-R Modulation Phase)	NORM, INV	Phase of the right channel modulation: Normally, you will leave this at Normal (NORM). If you specify Inverted (INV), the modulation (upward/downward movement) of the right channel is inverted.
L Phase (CH-L Phase)		Phase when mixing the flanging sound with the original sound NORM: normal phase INV: inverse phase
R Phase (CH-R Phase)		
Level	0–127	Output Level

SDD-320 (Dimension D)

This models Roland's DIMENSION D (SDD-320). It provides a clear chorus sound.



Parameter	Value	Explanation
Mode	1, 2, 3, 4, 1+4, 2+4, 3+4	Switches the mode.
Low Gain	-15--+15 [dB]	Amount of boost/cut for the low-frequency range
High Gain	-15--+15 [dB]	Amount of boost/cut for the high-frequency range
Level	0-127	Output Level

2Tap PanDly (2 Tap Pan Delay)

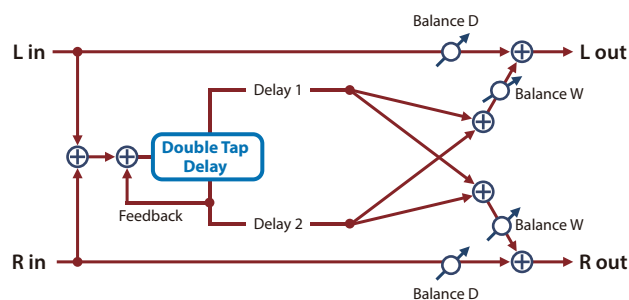

Parameter	Value	Explanation
Delay Sync (Delay Time (sync switch))	OFF, ON	If this is ON, the delay synchronizes with the tempo.
D. Time(ms) (Delay Time (msec))	1-2600	Adjusts the time until the second delay sound is heard.
D. Time(Nt) (Delay Time (note))	Note → "Note" (p. 64)	
Dly Fbk (Delay Feedback)	-98--+98 [%]	Adjusts the proportion of the delay sound that is fed back into the effect. Negative (-) settings will invert the phase.
Dly HF (Delay HF Damp)	200, 250, 315, 400, 500, 630, 800, 1000, 1250, 1600, 2000, 2500, 3150, 4000, 5000, 6300, 8000, BYPASS [Hz]	Adjusts the frequency above which sound fed back to the effect is filtered out. If you don't want to filter out any high frequencies, set this parameter to BYPASS.
Dly1 Pan (Delay 1 Pan)	L64-63R	Stereo location of Delay 1
Dly2 Pan (Delay 2 Pan)	L64-63R	Stereo location of Delay 2
Dly1 Lv (Delay 1 Level)	0-127	Volume of delay 1
Dly2 Lv (Delay 2 Level)	0-127	Volume of delay 2
Low Gain	-15--+15 [dB]	Amount of boost/cut for the low-frequency range
High Gain	-15--+15 [dB]	Amount of boost/cut for the high-frequency range
Balance	D100: 0W-D0: 100W	Adjusts the volume balance between the sound that is sent through the delay (W) and the sound that is not sent through the delay (D).
Level	0-127	Output Level

Transient

This effect lets you control the way in which the sound attacks and decays.

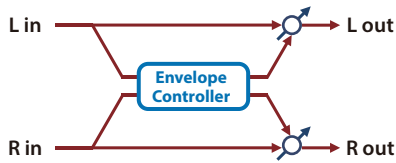

Parameter	Value	Explanation
Attack	-50–+50	Character of the attack. Higher values make the attack more aggressive; lower values make the attack milder.
Release	-50–+50	Character of the decay. Higher values make the sound linger; lower values make the sound cut off quickly.
Out Gain (Output Gain)	-24–+12 [dB]	Output gain
Sens (Sense)	LOW, MID, HIGH	Quickness with which the attack is detected
Level	0–127	Output Level

Mid-Side EQ (Mid-Side Equalizer)

This effect allows the left/right signals that have similar phase to be tonally adjusted in a different way than the left/right signals that have different phase.



Parameter	Value	Explanation
M EQ Switch	OFF, ON	Switches whether to apply tonal adjustment to left/right input signals whose phase is similar (in phase).
M In G (M Input Gain)	-12.00–+12.00 [dB]	Volume of left/right input signals whose phase is similar (in phase)
M Low F (M Low Frequency)	20, 25, 31, 40, 50, 63, 80, 100, 125, 160, 200, 250, 315, 400 [Hz]	Frequency of the low range
M Low G (M Low Gain)	-12.00–+12.00 [dB]	Amount of boost/cut for the low-frequency range
M Mid1 F (M Mid1 Frequency)	200, 250, 315, 400, 500, 630, 800, 1000, 1250, 1600, 2000, 2500, 3150, 4000, 5000, 6300, 8000 [Hz]	Frequency of the middle range 1
M Mid1 G (M Mid1 Gain)	-12.00–+12.00 [dB]	Gain of the middle range 1
M Mid1 Q	0.5, 1.0, 2.0, 4.0, 8.0	Width of the middle range 1 Set a higher value for Q to narrow the range to be affected.
M Mid2 F (M Mid2 Frequency)	200, 250, 315, 400, 500, 630, 800, 1000, 1250, 1600, 2000, 2500, 3150, 4000, 5000, 6300, 8000 [Hz]	Frequency of the middle range 2
M Mid2 G (M Mid2 Gain)	-12.00–+12.00 [dB]	Gain of the middle range 2
M Mid2 Q	0.5, 1.0, 2.0, 4.0, 8.0	Width of the middle range 2 Set a higher value for Q to narrow the range to be affected.
M Mid3 F (M Mid3 Frequency)	200, 250, 315, 400, 500, 630, 800, 1000, 1250, 1600, 2000, 2500, 3150, 4000, 5000, 6300, 8000 [Hz]	Frequency of the middle range 3
M Mid3 G (M Mid3 Gain)	-12.00–+12.00 [dB]	Gain of the middle range 3
M Mid3 Q	0.5, 1.0, 2.0, 4.0, 8.0	Width of the middle range 3 Set a higher value for Q to narrow the range to be affected.
M High F (M High Frequency)	2000, 2500, 3150, 4000, 5000, 6300, 8000, 10000, 12500, 16000 [Hz]	Frequency of the high range
M High G (M High Gain)	-12.00–+12.00 [dB]	Amount of boost/cut for the high-frequency range
S EQ Switch	OFF, ON	Switches whether to apply tonal adjustment to left/right input signals whose phase is distant (opposite phase).
S In G (S Input Gain)	-12.00–+12.00 [dB]	Volume of left/right signals whose phase is distant (opposite phase)

Parameter	Value	Explanation
S Low F (S Low Frequency)	20, 25, 31, 40, 50, 63, 80, 100, 125, 160, 200, 250, 315, 400 [Hz]	Frequency of the low range
S Low G (S Low Gain)	-12.00–+12.00 [dB]	Amount of boost/cut for the low-frequency range
S Mid1 F (S Mid1 Frequency)	200, 250, 315, 400, 500, 630, 800, 1000, 1250, 1600, 2000, 2500, 3150, 4000, 5000, 6300, 8000 [Hz]	Frequency of the middle range 1
S Mid1 G (S Mid1 Gain)	-12.00–+12.00 [dB]	Gain of the middle range 1
S Mid1 Q	0.5, 1.0, 2.0, 4.0, 8.0	Width of the middle range 1 Set a higher value for Q to narrow the range to be affected.
S Mid2 F (S Mid2 Frequency)	200, 250, 315, 400, 500, 630, 800, 1000, 1250, 1600, 2000, 2500, 3150, 4000, 5000, 6300, 8000 [Hz]	Frequency of the middle range 2
S Mid2 G (S Mid2 Gain)	-12.00–+12.00 [dB]	Gain of the middle range 2
S Mid2 Q	0.5, 1.0, 2.0, 4.0, 8.0	Width of the middle range 2 Set a higher value for Q to narrow the range to be affected.
S Mid3 F (S Mid3 Frequency)	200, 250, 315, 400, 500, 630, 800, 1000, 1250, 1600, 2000, 2500, 3150, 4000, 5000, 6300, 8000 [Hz]	Frequency of the middle range 3
S Mid3 G (S Mid3 Gain)	-12.00–+12.00 [dB]	Gain of the middle range 3
S Mid3 Q	0.5, 1.0, 2.0, 4.0, 8.0	Width of the middle range 3 Set a higher value for Q to narrow the range to be affected.
S High F (S High Frequency)	2000, 2500, 3150, 4000, 5000, 6300, 8000, 10000, 12500, 16000 [Hz]	Frequency of the high range
S HighG (S High Gain)	-12.00–+12.00 [dB]	Amount of boost/cut for the high-frequency range
Level	0–127	Output Level

M/S Comp (Mid-Side Compressor)

This effect allows the left/right signals that have similar phase to be adjusted to a different sense of volume than the left/right signals that have different phase.

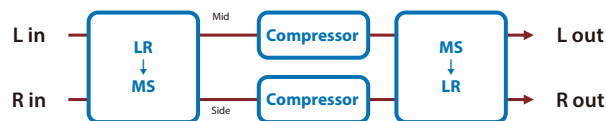

Parameter	Value	Explanation
M Comp Sw (M Comp Switch)	OFF, ON	Switches whether to adjust the sense of volume for left/right input signals whose phase is similar (in phase).
M Attack	0–124	Sets the speed at which compression starts
M Release	0–124	Adjusts the time after the signal volume falls below the Threshold Level until compression is no longer applied.
M Thres (M Threshold)	-60–0 [dB]	Adjusts the volume at which compression begins
M Knee	0–30 [dB]	This is a function that smooths the onset of compression from the uncompressed state; it gradually applies compression starting earlier than Threshold. Higher values produce a smoother transition.
M Ratio	1: 1, 1.5: 1, 2: 1, 4: 1, 16: 1, INF: 1	Compression ratio
M Gain (M Post Gain)	0–+18 [dB]	Adjusts the output gain.
S Comp Sw (s Compressor Switch)	OFF, ON	Switches whether to adjust the sense of volume for left/right input signals whose phase is distant (opposite phase).
S Attack	0–124	Sets the speed at which compression starts
S Release	0–124	Adjusts the time after the signal volume falls below the Threshold Level until compression is no longer applied.
S Thres (S Threshold)	-60–0 [dB]	Adjusts the volume at which compression begins
S Knee	0–30 [dB]	This is a function that smooths the onset of compression from the uncompressed state; it gradually applies compression starting earlier than Threshold. Higher values produce a smoother transition.
S Ratio	1: 1, 1.5: 1, 2: 1, 4: 1, 16: 1, INF: 1	Compression ratio
S Gain (S Post Gain)	0–+18 [dB]	Adjusts the output gain.
Level	0–127	Output Level

Fattener (Tone Fattener)

This effect applies distinctive distortion, adding overtones to give more depth to the sound.

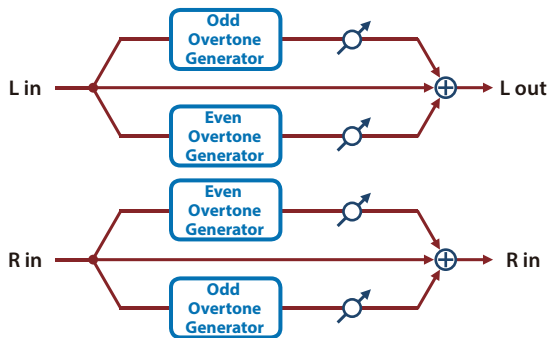

Parameter	Value	Explanation
Odd Level	0–400 [%]	Raising the value adds odd-order overtones.
Even Level	0–400 [%]	Raising the value adds even-order overtones.
Level	0–127	Output Level

M/S Delay (Mid Side Delay)

This effect applies different amounts of delay to left/right signals of similar phase and differing phase.

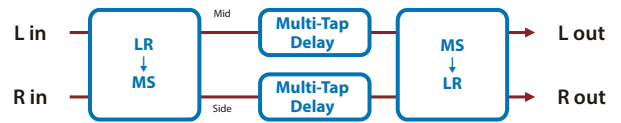

Parameter	Value	Explanation
MD Level	0–127	Delay volume of left/right input signals whose phase is similar (in phase)
MD Mode	2TAP, 3TAP, 4TAP	Delay divisions for the input signals whose left/right phase is similar (identical phase)
MD Tm Sync	OFF, ON	If this is ON, the delay synchronizes with the tempo.
MD Time	1–1300	Adjusts the delay time from the direct sound until the delay sound is heard.
MDTime Nt	Note ➔ "Note" (p. 64)	
MD Feedback	-98–+98 [%]	Adjusts the proportion of the delay sound that is fed back into the effect. Negative (-) settings will invert the phase.
MD HFDamp	200, 250, 315, 400, 500, 630, 800, 1000, 1250, 1600, 2000, 2500, 3150, 4000, 5000, 6300, 8000, BYPASS [Hz]	Adjusts the frequency above which sound fed back to the effect is filtered out. If you don't want to filter out any high frequencies, set this parameter to BYPASS.
MD1 Pan	L64–63R	Panning of the first delay sound
MD2 Pan	L64–63R	Panning of the second delay sound
MD3 Pan	L64–63R	Panning of the third delay sound
MD4 Pan	L64–63R	Panning of the fourth delay sound
SD Level	0–127	Delay volume of left/right input signals whose phase is distant (opposite phase)
SD Mode	2TAP, 3TAP, 4TAP	Delay divisions for the input signals whose left/right phase is distant (reverse phase)
SD Tm Sync	OFF, ON	If this is ON, the delay synchronizes with the tempo.
SD Time	1–1300	Adjusts the delay time from the direct sound until the delay sound is heard.
SDTime Nt	Note ➔ "Note" (p. 64)	
SD Feedback	-98–+98 [%]	Adjusts the proportion of the delay sound that is fed back into the effect. Negative (-) settings will invert the phase.
SD HFDamp	200, 250, 315, 400, 500, 630, 800, 1000, 1250, 1600, 2000, 2500, 3150, 4000, 5000, 6300, 8000, BYPASS [Hz]	Adjusts the frequency above which sound fed back to the effect is filtered out. If you don't want to filter out any high frequencies, set this parameter to BYPASS.
SD1 Pan	L64–63R	Panning of the first delay sound
SD2 Pan	L64–63R	Panning of the second delay sound
SD3 Pan	L64–63R	Panning of the third delay sound
SD4 Pan	L64–63R	Panning of the fourth delay sound
Level	0–127	Output Level

EP Amp Sim (RD EP Amp Simulator)

This is an effect that was developed for the RD series SuperNatural E.Piano.

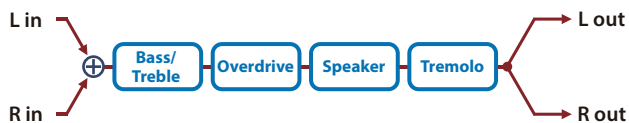

Parameter	Value	Explanation
Bass	-50+50	Amount of low-frequency boost/cut
Treble	-50+50	Amount of high-frequency boost/cut
Tremolo Sw	OFF, ON	Tremolo on/off
Type		Type of tremolo effect
	OLDCASE MO	A standard electric piano sound of the early 70s (mono)
	OLDCASE ST	A standard electric piano sound of the early 70s (stereo)
	NEWCASE	A standard electric piano sound of the late 70s and early 80s
	DYNO	A classic modified electric piano
	WURLY	A classic electric piano of the '60s
Speed Sync	OFF, ON	If this is ON, the rate synchronizes with the tempo of the rhythm. ➔ "Tempo" (p. 16)
Speed	0.05–10.00 [Hz]	
Speed Nt	Note ➔ "Note" (p. 64)	Rate of the tremolo effect
Depth	0–127	Depth of the tremolo effect
Shape	0–20	Adjusts the waveform of the tremolo.
AMP	OFF, ON	Turns the speaker and distortion on/off
Speaker	LINE, OLD, NEW, WURLY, TWIN	Type of speaker If LINE is selected, the sound will not be sent through the speaker simulation.
Drive	0–127	Degree of distortion Also changes the volume.
Level	0–127	Output Level

DJFX Looper

Loops a short portion of the input sound. You can vary the playback direction and playback speed of the input sound to add turntable-type effects.

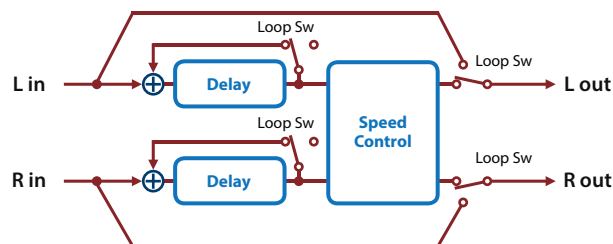

Parameter	Value	Explanation
Length	230–23 (not straight)	Specifies the length of the loop.
Speed	-1.00+1.00	Specifies the playback direction and playback speed. - direction: Reverse playback + direction: Normal playback 0: Stop playback As the value moves away from 0, the playback speed becomes faster.
Loop Sw	OFF, ON	If you turn this on while the sound is heard, the sound at that point will be looped. Turn this off to cancel the loop. * If the effect is recalled with this ON, this parameter must be turned OFF and then turned ON again in order to make the loop operate.
Level	0–127	Output Level

BPM Looper

Loops a short portion of the input sound. This can automatically turn the loop on/off in synchronization with the rhythm.

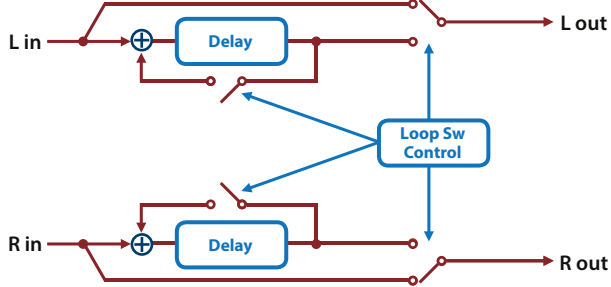

Parameter	Value	Explanation
Length	230–23 (not straight)	Specifies the length of the loop.
Rate Sync	OFF, ON	If this is ON, the rate synchronizes with the tempo of the rhythm. → "Tempo" (p. 16)
Rate	0.05–10.00 [Hz]	
Rate Note	Note → "Note" (p. 64)	Cycle at which the loop automatically turns on/off
Timing	1–8	Specifies the timing within the cycle at which the loop automatically starts (which step of the eight timing divisions at which the sound is heard)
Lenth	1–8	Specifies the length at which the loop automatically ends within the cycle (the number of times that the 1/8-length of sound is heard)
Loop Mode	OFF, AUTO, ON	If this is AUTO, the loop automatically turns on/off in synchronization with the rhythm. * If the effect is recalled with this ON, this parameter must first be set to something other than ON in order to make the loop operate.
Level	0–127	Output Level

Saturator

This effect combines overdrive and filter.

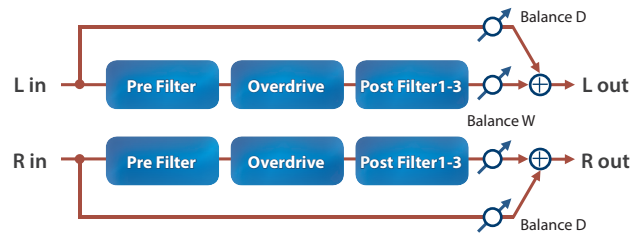

Parameter	Value	Explanation
Pre Type	THRU, LPF, HPF, LSV, HSV	Type of filter that precedes the distortion processing THRU: No filter is applied LPF: A filter that passes the sound below the specified frequency HPF: A filter that passes the sound above the specified frequency LSV: A filter that boosts/cuts the sound below the specified frequency HSV: A filter that boosts/cuts the sound above the specified frequency
Pre Freq	20–16000 [Hz]	Frequency at which the pre-distortion filter operates
Pre Gain	-24.0–+24.0 [dB]	For the LSV/HSV types, the amount of boost/cut
Drive	0.0–48.0 [dB]	Strength of distortion
Post1 Type	THRU, LPF, HPF, LSV, HSV	Type of filter 1 which follows the distortion processing
Post1 Frq	20–16000 [Hz]	Frequency at which post-distortion filter 1 operates
Post1 Gain	-24.0–+24.0 [dB]	For the LSV/HSV types, the amount of boost/cut
Post2 Type	THRU, LPF, HPF, LSV, HSV	Type of filter 2 which follows the distortion processing
Post2 Frq	20–16000 [Hz]	Frequency at which post-distortion filter 2 operates
Post2 Gain	-24.0–+24.0 [dB]	For the LSV/HSV types, the amount of boost/cut
Post3 Type	THRU, LPF, HPF, BPF, PKG	Type of filter 3 which follows the distortion processing THRU: No filter is applied LPF: A filter that passes the sound below the specified frequency HPF: A filter that passes the sound above the specified frequency BPF: A filter that passes only the specified frequency PKG: A filter that boosts/cuts the specified frequency
Post3 Frq	20–16000 [Hz]	Frequency at which post-distortion filter 3 operates
Post3 Gain	-24.0–+24.0 [dB]	For the PKG type, the amount of boost/cut
Post3 Q	0.5–16.0	Width of the frequency range affected by the filter
Sense	-60.0–0.0 [dB]	Adjust this value so that the sound is not made louder when distortion is applied.
PostGain	-48.0 +12.0 [dB]	Gain following distortion processing
Balance	D100: 0W–D0: 100W	Volume balance between the dry sound (D) and effect sound (W)
Level	0–127	Output Level

W Saturator (Worm Saturator)

This is a variety of saturator, and is distinctive for its warmer sound.

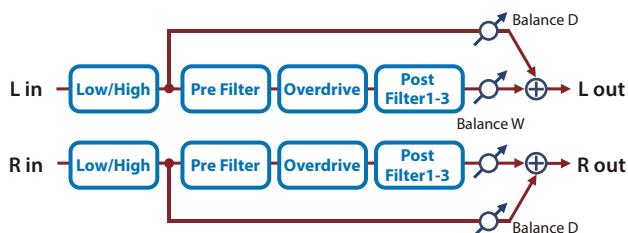

Parameter	Value	Explanation
LowFreq	20–16000 [Hz]	Input filter (low range) Boosts/cuts the sound below the specified frequency.
LowGain	-24.0–+24.0 [dB]	Amount of boost/cut
Hi Slope	THRU, -12dB, -24dB	Input filter (high range) Boosts/cuts the sound above the specified frequency.
Hi Freq	20–16000 [Hz]	Amount of boost/cut
Pre1 Type	THRU, LPF, HPF, LSV, HSV	Type of filter that precedes the distortion processing THRU: No filter is applied LPF: A filter that passes the sound below the specified frequency HPF: A filter that passes the sound above the specified frequency LSV: A filter that boosts/cuts the sound below the specified frequency HSV: A filter that boosts/cuts the sound above the specified frequency
Pre1 Freq	20–16000 [Hz]	Frequency at which the pre-distortion filter operates
Pre1 Gain	-24.0–+24.0 [dB]	For the LSV/HSV types, the amount of boost/cut
Drive	0.0–48.0 [dB]	Strength of distortion
Post1 Type	THRU, LPF, HPF, LSV, HSV	Type of filter 1 which follows the distortion processing
Post1 Freq	20–16000 [Hz]	Frequency at which post-distortion filter 1 operates
Post1 Gain	-24.0–+24.0 [dB]	For the LSV/HSV types, the amount of boost/cut
Post2 Type	THRU, LPF, HPF, LSV, HSV	Type of filter 2 which follows the distortion processing
Post2 Freq	20–16000 [Hz]	Frequency at which post-distortion filter 2 operates
Post2 Gain	-24.0–+24.0 [dB]	For the LSV/HSV types, the amount of boost/cut
Post3 Type	THRU, LPF, HPF, BPF, PKG	Type of filter 3 which follows the distortion processing THRU: No filter is applied LPF: A filter that passes the sound below the specified frequency HPF: A filter that passes the sound above the specified frequency BPF: A filter that passes only the specified frequency PKG: A filter that boosts/cuts the specified frequency
Post3 Freq	20–16000 [Hz]	Frequency at which post-distortion filter 3 operates
Post3 Gain	-24.0–+24.0 [dB]	For the PKG type, the amount of boost/cut
Post3 Q	0.5–16.0	Width of the frequency range affected by the filter

Parameter	Value	Explanation
Sense	-60.0–0.0 [dB]	Adjust this value so that the sound is not made louder when distortion is applied.
PostGain	-48.0–+12.0 [dB]	Gain following distortion processing
Balance	D100: 0W–D0: 100W	Volume balance between the dry sound (D) and effect sound (W)
Level	0–127	Output Level

Fuzz

Adds overtones and intensely distorts the sound.

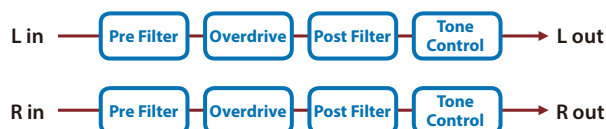

Parameter	Value	Explanation
Drive	0–127	Adjusts the depth of distortion. This also changes the volume.
Tone	0–100	Sound quality of the Overdrive effect
Level	0–127	Output Level

JUNO Chorus (JUNO-106Chorus)

This models the chorus effects of the Roland JUNO-106.

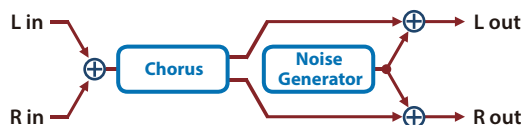

Parameter	Value	Explanation
Mode	I, II, I+II, JX I, JX II	Type of Chorus I+II: The state in which two buttons are pressed simultaneously.
Noise Lv	0–127	Volume of the noise produced by chorus
Balance	D100: 0W–D0: 100W	Volume balance between the dry sound (D) and effect sound (W)
Level	0–127	Output Level

MM Filter (Multimode Filter)

This is a filter that is adjusted for effective use in a DJ performance.

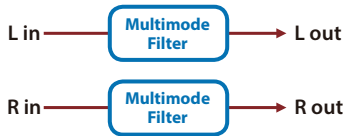

Parameter	Value	Explanation
Type	LPF/HPF, LPF, HPF, BPF	Type of filter LPF/HPF: The filter type is automatically switched according to the Filter Tone parameter value.
Tone	0–255	Frequency at which the filter operates
Color	0–255	Filter resonance level Higher values more strongly emphasize the region of the operating frequency.
Slope	-12, -24, -36 [dB]	Amount of attenuation per octave -12 dB: gentle -24 dB: steep -36 dB: extremely steep
Gain	0–+12 [dB]	Amount of boost for the filter output
Level	0–127	Output Level

HMS Distort

This is a distortion-type effect that models the vacuum tube amp section of a rotary speaker of the past.

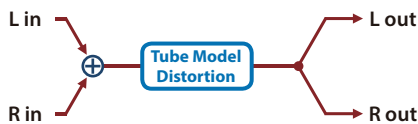

Parameter	Value	Explanation
Dist	0–127	Strength of distortion
Level	0–127	Output Level

Script 100

This simulates an analog phaser of the past.

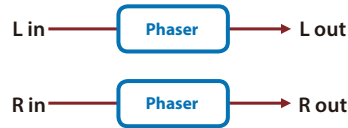

Parameter	Value	Explanation
Rate Sync	OFF, ON	If this is ON, the rate synchronizes with the tempo of the rhythm. → "Tempo" (p. 16)
Rate	0.05–10.00 [Hz]	Frequency of modulation
Rate Note	Note → "Note" (p. 64)	
Duty	-50–50	Adjusts the ratio of speeds at which the modulation rises or falls.
Min	0–100	Lower limit reached by modulation
Max	0–100	Upper limit reached by modulation
Manual Sw	OFF, ON	Applies modulation according to the value of the Manual parameter, rather than modulating automatically.
Manual	0–100	Adjusts the basic frequency from which the sound will be modulated.
Resonance	0–66	Amount of feedback
Mix	0–127	Level of the phase-shifted sound
Level	0–127	Output Level

Note

1/64T Sixty-fourth-note triplet	1/64 Sixty-fourth note	1/32T Thirty-second-note triplet	1/32 Thirty-second note
1/16T Sixteenth-note triplet	1/32D Dotted thirty-second note	1/16 Sixteenth note	1/8T Eighth-note triplet
1/16D Dotted sixteenth note	1/8 Eighth note	1/4T Quarter-note triplet	1/8D Dotted eighth note
1/4 Quarter note	1/2T Half-note triplet	1/4D Dotted quarter note	1/2 Half note
1/1T Whole-note triplet	1/2D Dotted half note	1/1 Whole note	2/1T Double-note triplet
1/1D Dotted whole note	2/1 Double note		